



ROBOJOB
FIRST IN CNC AUTOMATION



TURN-ASSIST MANUAL

ORIGINAL INSTRUCTIONS Second generation

RoboJob Turn-Assist Manual

Version 2.0.2

Generated on 2019-08-29 14:24:34 +0200



Table of Contents

Preface	v
1. Introduction	1
2. Hardware	3
2.1. System components	3
2.1.1. Stacking devices	3
2.1.2. Robot	6
2.1.3. Part pusher	7
2.1.4. Industrial Personal Computer	8
2.2. Powering on/off	9
2.2.1. Powering on	9
2.2.2. Powering off	9
2.3. Safety	9
2.3.1. Emergency stops	9
2.3.2. Safety devices	10
2.3.3. HOLD and RUN buttons	13
3. Software	15
3.1. Screen layout	15
3.1.1. Main menu	16
3.2. Start	18
3.2.1. Active process	19
3.2.2. Process management	20
3.3. Configure	21
3.3.1. Workpieces	21
3.3.2. Devices	23
3.3.3. Save button	29
3.4. Position	30
3.4.1. Transport actions	30
3.4.2. Teaching	37
3.5. Automate	41
3.5.1. Status	41
3.5.2. Layout	44
3.5.3. Interventions	44
3.6. Admin	45
3.6.1. Preferences	45
3.6.2. Robot	45
3.6.3. Servo stacker	47
3.6.4. Import	47
3.6.5. Software info	47
3.6.6. Grids	47
3.6.7. Fixtures	50
3.6.8. Jawsets	51
3.6.9. Material	54
3.6.10. Shaft caliber	54
3.6.11. Export	55
A. List of alarms	57
A.1. Robot alarms	57
A.2. CNC alarms	57
A.2.1. Doors	57
A.2.2. Machine	58
A.2.3. Action	58
A.2.4. Ethernet	65
A.2.5. Others	66
A.3. Servo Stacker alarms	66
A.3.1. General	66
A.3.2. Timeout	67
A.3.3. Motor	67



Preface

This manual belongs to the RoboJob system as delivered by RoboJob nv from Heist-op-den-Berg. In this manual you will find all information to be able to work with the installation.

This manual contains an overview of the possibilities of the installation. Nevertheless, it may happen that this manual contains more information than actually installed, because certain things are configured differently or are considered 'optional'. On the other hand, it may be that this manual contains less information than the installed system, since certain items can be considered 'customer specific'.

The content of this document is subdivided into two main parts: hardware and software. The first part, hardware, gives an overview of the system's main components, how to start-up and shut-down the system and a brief summary of the commonly used safety systems. In the second part, software, a detailed description of the software platform is presented.

1 Introduction

This section contains general information and the safety precautions for using the robot.



Be sure to observe the safety precautions in this manual. Failure may cause personal injury or material damage.



No modifications should be performed that will affect operation safety. If such modifications are required, please contact our RoboJob Helpdesk for assistance.



For the purpose of explaining the operation of the machine and equipment, some illustrations may not include safety features such as covers, doors, etc. Before operation, make sure all such items are in place.



This manual was considered complete and accurate at the time of publication, however due to our desire to constantly improve the quality and specification of all our products, it is subject to change or modification. If you have any questions, please contact our RoboJob Helpdesk.



Before using this machine and equipment, fully understand the contents of this manual to ensure proper operation. If any questions arise, please contact our RoboJob Helpdesk.



Always keep this manual near the machine for immediate use. If anything is unclear, please contact our RoboJob Helpdesk.



No part of this manual may be reproduced in any form.



2 Hardware

This part gives an overview of the system's main components, how to start-up and shut-down the system and a brief summary of the commonly used safety systems.

2.1. System components

This section will present the different components that are part of a RoboJob system. These components can be subdivided into four categories:

- Stacking devices are used to store the raw and finished workpieces.
- The robot is responsible for transporting workpieces to and from the CNC machine where they are processed.
- A part pusher can be installed on top of a gripper to push workpieces into the clamps of the CNC machine.
- The industrial personal computer (IPC) is used to interact with the system.

2.1.1. Stacking devices

A stacking device is a device that is used to store raw workpieces before they are processed, finished workpieces after they are processed or half-finished workpieces in between processing. This section is an overview of the possible stacking devices that can be used with a RoboJob system.

Please note that most installations will only contain some of these devices, so not every device will be present at your installation.

Essential stacker

The essential stacker is the most basic version of the RoboJob stacker tables. It is flexible and support a large range of workpieces, but has a limited capacity. The essential stacker's main component is a milled metal plate containing a pattern of holes. Studs will be placed in these holes creating a support system to align the workpieces. The RoboJob software indicates which stud positions are needed, taking into account the workpiece dimensions. Studs are available in 2 different heights: 25mm and 75mm.

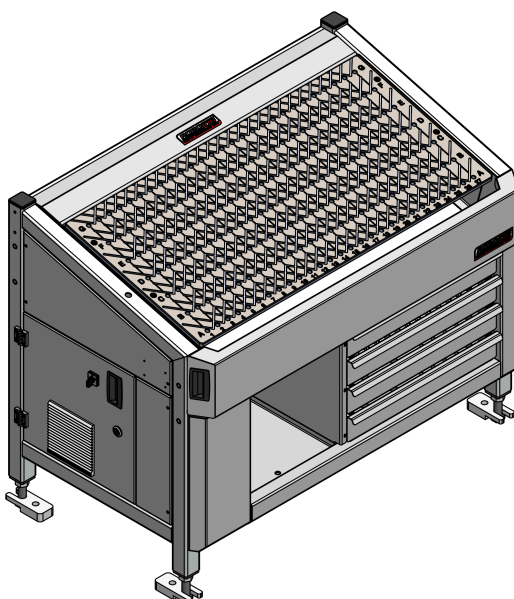

Figure 2.1. Essential stacker

200 stacker

The 200 stacker can be compared to the 180 stacker. The stacker consists of two milled metal plates containing a pattern of holes. Metal pillars will be placed in these holes creating a support system to align the workpieces. The RoboJob software indicates which stud positions are needed, taking into account the workpiece dimensions. This stacker can load and unload workpieces with a diameter up to 200mm.

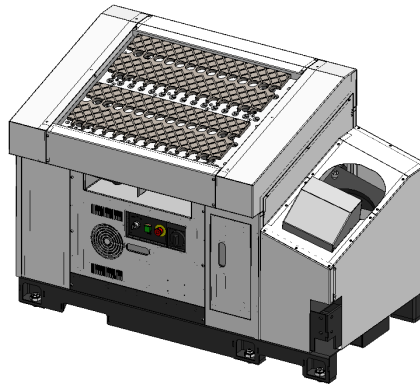

Figure 2.2. 200 stacker

270 stacker

The 270 stacker is similar to the 200 stacker, but it is bigger and has a larger capacity. It is suitable for workpieces with a diameter up to 270mm.

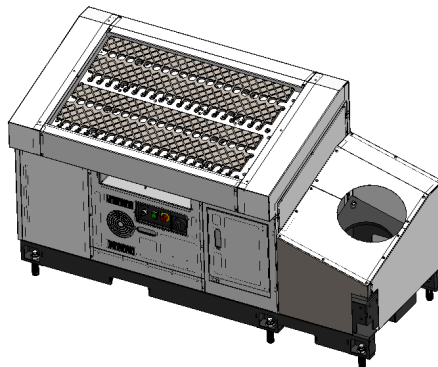

Figure 2.3. 270 stacker

Shaft rack

A shaft rack is a support system for shaft workpieces. It is assembled on top of a stacker. This system allows to load and unload shafts. It is the main part of the RoboJob shaft option. The shaft rack is a removable structure placed on top of the stacker. This makes it possible to easily switch between workpiece types. The shaft rack can be adjusted for different size shafts with different size dividers. The software will indicate which divider to use. Most installations with shaft option have a shaft-edge detection sensor for precise positioning in the machine.

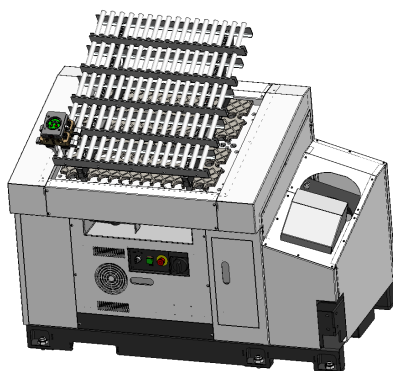

Figure 2.4. Shaft Rack on top of 200 stacker

Pallet

A pallet can be used for stacking raw or finished workpieces. Pallets can have a variety of forms and functions. Most commonly metal pallets with studs or calibres are used to stack raw workpieces for exact positioning when loading the machine. After processing, a plain, ordinary wooden pallet is often used to unload the workpieces. Different types of docking stations or removable support systems can be used to position the pallet.

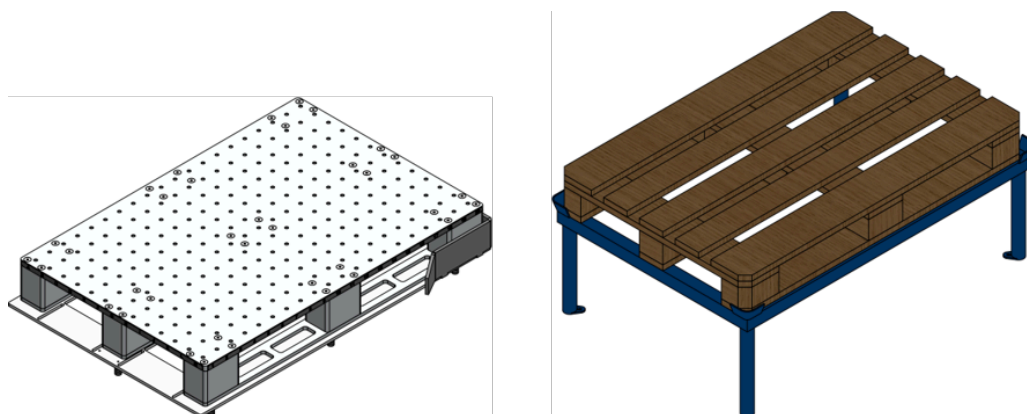

Figure 2.5. Metal pallet (left) and wooden pallet on pallet support (right)

Revolving unit

A revolving unit is typically used for rotating workpieces in between processing. A workpiece will be placed on this device, and subsequently gripped using a different orientation. This way, it is possible to process multiple sides of the workpiece. In most cases the revolving unit can be configured based on the dimensions of the work pieces.

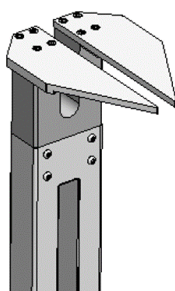

Figure 2.6. Revolving unit for workpieces on Turn-Assist

Bin

Finished workpieces can be dropped in a bin, a box or a slide. This box can be placed in a separate location or attached to another stacking device. The advantages are the increased capacity and the potential for using easier to transport containers.

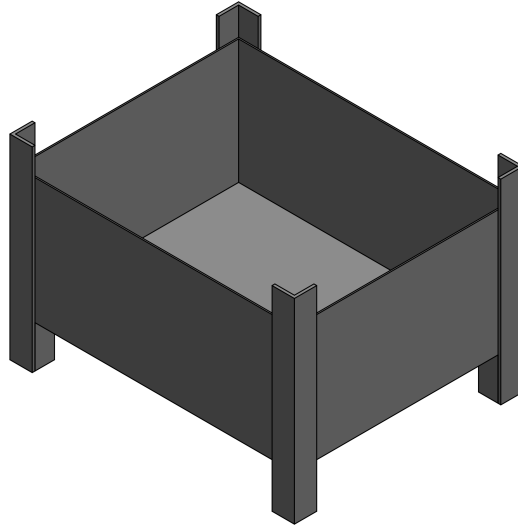

Figure 2.7. Bin

2.1.2. Robot

General

Robots vary in size depending on their maximum payload. Robots typically found in RoboJob installations are:

- Fanuc M-10iA/12: payload of 12kg
- Fanuc M-20iA: payload of 20kg
- Fanuc M-20iA/35M: payload of 35kg
- Fanuc M-710iC/45M: payload of 45kg
- Fanuc M-710iC/70: payload of 70kg

Teach pendant

A teach pendant is provided for each robot and is used for controlling the robot. The teach pendant has a switch on the top-left to enable controlling the robot. When working in automatic mode using the RoboJob software, the enable switch should be in the off state. In case the robot has to be moved manually, extra safety measures are in place. To be able to manually jog the robot, at least one of the two deadman switches should be hold in the safe positions. The deadman switches are located on the back of the teach pendant and have three positions:

- Not pressed
- Safe middle position
- Fully pressed

The teach pendant is rarely used while operating the RoboJob system. It will be explicitly mentioned whenever the teach pendant is needed in the remainder of this manual.



Figure 2.8. Teach pendant

Controller cabinet

The controller cabinet contains the power supply and control logic of the robot. Access to this cabinet is required for using the power switch or for changing the robots operation mode. There are three operation modes:

- AUTO: This is the default operation mode. The robot can work autonomously and at full speed. All safety systems are activated. For typical RoboJob installations only this operation mode will be used.
- T1: Teach mode is activated. The robot speed is limited and the fence safety system is de-activated. The robot can only move if the teach pendant is switched on and if the deadman switch is pressed.
- T2: This mode equals T1, but now the robot can move at full speed.

It is not allowed to use the T2 mode, as full speed robot movements without the fence safety system in place can result in dangerous situations. Only trained technicians are allowed use this mode.

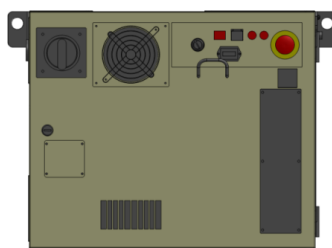

Figure 2.9. Robot controller cabinet

2.1.3. Part pusher

An additional feature for the grippers of the robot is the part pusher. This is a unique spring pressure system for grippers. The spring pushes the workpiece in the chucks of the CNC-machine to make sure the workpiece is perfectly positioned against the CNC-machine.

The part pusher can be mounted onto the gripper using three predefined holes at the side of the gripper. With the use of three small pins, the three pins at the top of the gripper can be fixed. The upper part, to actually push the workpiece, is mounted on these three pins using screws.

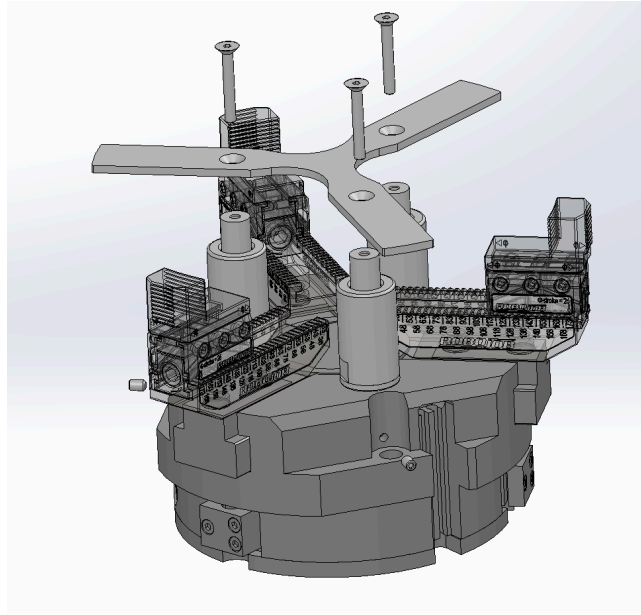

Figure 2.10. Part pusher

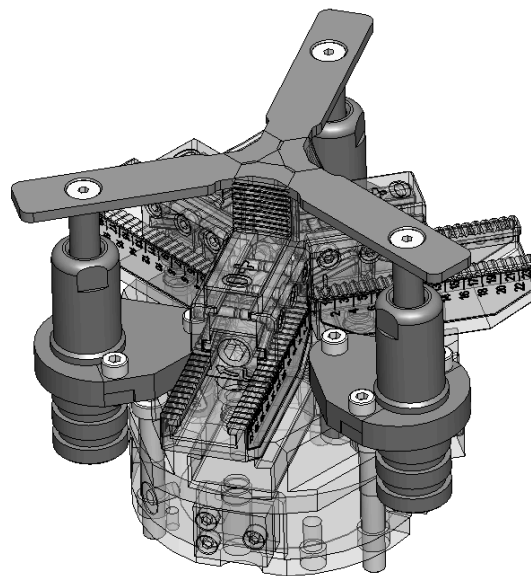

Figure 2.11. Part pusher: new technology

2.1.4. Industrial Personal Computer

All interactions with the software system take place on the Industrial Personal Computer (IPC). This computer is equipped with a touch screen to enter the necessary data.

Depending on the layout of an installation, the power switch for this computer can be found:

- On the left side of the stacker
- On the fence, close to the IPC

On the right side of the computer, three extra controls are present: an emergency stop button, a RUN button and a HOLD button. These will be discussed in more detail in **Safety**.

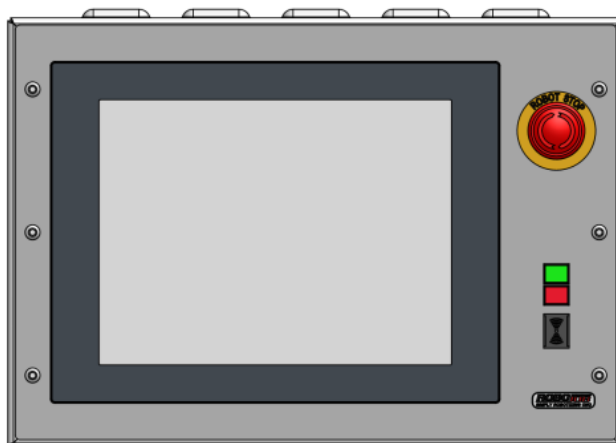

Figure 2.12. Industrial Personal Computer (IPC)

2.2. Powering on/off

This section describes how the system can be powered on and off.

2.2.1. Powering on

The next steps should be followed for powering on the system:

1. Make sure the CNC machine is powered on.
2. Power on the robot by using the power switch on the robot controller cabinet.
3. Power on the Industrial Personal Computer (IPC) by switching the power switch.
4. After the computer has started, start the software by double-clicking the icon on the desktop.

2.2.2. Powering off

The next steps should be followed for powering off the system:

1. Exit the software by pressing the exit button (top-right).
2. Shut down Windows.
3. After Windows has shut down, power off the IPC.
4. Power off the robot using the power switch on the robot controller cabinet.

2.3. Safety

In this section, three categories of safety measures are highlighted. First, an overview of emergency stops is given. Next, safety devices are discussed. Finally, the HOLD/RUN buttons are reviewed.

2.3.1. Emergency stops

Every installation has multiple emergency stop buttons to stop robot and machine in case of an emergency. The location and scope of the emergency stops are described in [Table 2.1, "Location and scope of emergency stops"](#). The air supply will continue to be present to prevent that in case of an emergency stop parts fall out of the grippers.

Please note that depending on the type of installation, the emergency stop circuit of the machine and robot may or may not be linked.

Operate the emergency stop only in case of an emergency or disaster. Improper use of the emergency stop is forbidden!

Location	Scope
Fanuc controller cabinet	Robot, <i>CNC machine</i> ^a
Fanuc Teach Pendant	Robot, <i>CNC machine</i> ^a
RoboJob IPC panel	Robot, <i>CNC machine</i> ^a
CNC machine	CNC machine, <i>Robot</i> ^a

^aWhen the emergency circuit of the robot and the machine are connected

Table 2.1. Location and scope of emergency stops

2.3.2. Safety devices

Safety laser scanner

Most RoboJob installations contain a safety laser scanner. This device forces the robot to slow down whenever a person approaches or stop when the person is too close. The scanner resets itself automatically, but if the robot was stopped, the robot alarms need to be reset and the RUN button has to be used to resume robot movement. It is the responsibility of the operator to check that the protected area is cleared and the installation is safe before resetting the robot.

microScan3



Figure 2.13. Safety laser scanners: microScan3

The indicators of the microScan3 consist of buttons and a display.

There are four buttons:

- (1) and (2) are arrows to change between different displays and menu items.
- (3) is the back button to change the previous display or higher-level menu items.
- (4) is the OK button to confirm or to show details. Pressing the OK button twice shows the menu.

Above the display four status LEDs can be found. At the same time the display indicates in which state the device is:

- (1) indicates the OFF state.
- (2) indicates the ON state.
- (3) shines if at least one warning field is interrupted.
- (4) flashes if the restart interlock is triggered.

Consult the manual of the safety laser scanner on the website of 'Sick' for more information about other status indications.

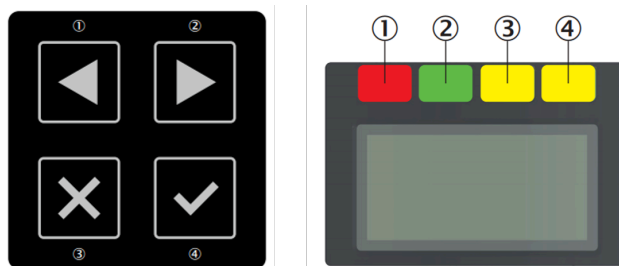

Figure 2.14. Indicators of a microScan3: buttons (left) and display (right)

Safety light curtain

Light curtains can be used as an alternative to laser scanners. Light curtains need to be reset manually after clearing the protected area. The reset button will always be located in a place where there is a good overview of the protected area. It is the responsibility of the operator to check that the protected area is cleared and the installation is safe before resetting the fence.

Consult the manual of the safety light curtain on the website of 'Sick' for more information.



Figure 2.15. Safety fence with safety light curtain

Safety fence

Safety fences are used along with laser scanners and light curtains. They form a physical barrier that prevents access to the robot. Make sure all fences are in place before using the robot.

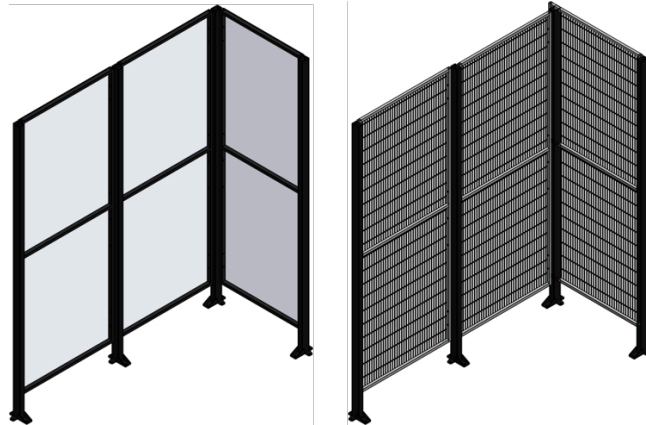

Figure 2.16. Safety fence with transparent polycarbonate panels (left) or with mesh panels (right)

Sometimes a door is present in the safety fence as an alternative to a safety scanner or light curtain. The door will have a sensor to trigger the safety system. The safety system needs to be reset manually after opening a door in the safety fence. The operator is responsible for ensuring the protected area is clear.

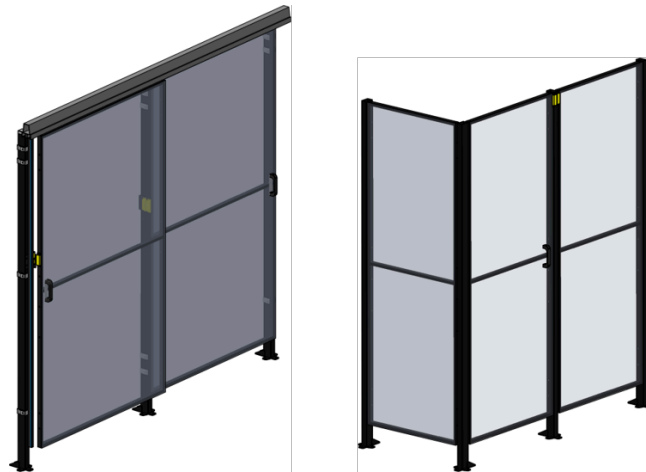

Figure 2.17. Safety fence with sliding doors (left) or hinged door (right)

Safety switch

Safety switches can be placed as an extra measure to prevent damage to other devices. I.e. for systems where the robot loads the machine through its front door, the CNC machine operator panel should be in a safe position for the robot to operate safely. This can be controlled using a safety switch.



Figure 2.18. Safety switch

2.3.3. HOLD and RUN buttons

The HOLD and RUN buttons are the respectively red and green buttons located next to IPC screen. Pressing the HOLD button will cause the robot to enter a controlled stop. The robot will be prevented from moving until all errors are cleared and the RUN button is pressed.

Pressing the RUN button will allow the robot to start or continue moving. Please note this will only succeed if no robot errors are active.

Both buttons have a led, which indicates the robots current state.

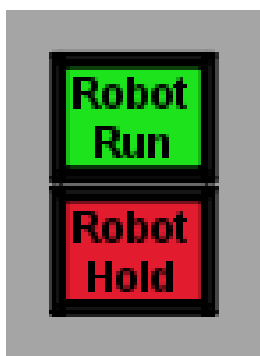

Figure 2.19. Robot run and hold buttons



3

Software

A detailed description of the software platform is presented in this chapter. This software platform is used to set-up, configure and run automation processes. For different workpieces, different automation process can be created.

Setting up an automation process consists of four parts:

- **Start:** First the process structure is defined. This part is used to indicate which devices are used and which steps the workpiece should go through, for example one or two machine processing steps.
- **Configure:** The workpiece data is entered and each device is configured.
- **Position:** During this part the grippers are selected and the exact locations of where workpieces are picked and placed are defined.
- **Automate:** Finally the automation is started. After reviewing the general screen layout, each of these parts will be discussed in more detail.

3.1. Screen layout

The screen is composed of three parts:

1. **The main menu** is used to navigate between the four parts of setting up an automation process explained in the [introduction](#). On the left, two buttons are present. These are used to show and hide the alarms and robot pop-overs, which will be discussed later. On the right two other buttons are present. The first is used to open the administration part of the software. The second is used to exit the system.
2. **The process** is a visual representation of the steps in an automation process. While setting up the automation this representation is used to navigate between the steps in the automation process.
3. The contents of this part changes depending on the navigation. During start, configuring and positioning this part of the screen is used to set up the process. This part is also used to start the automation and look at the status while the automation is running.

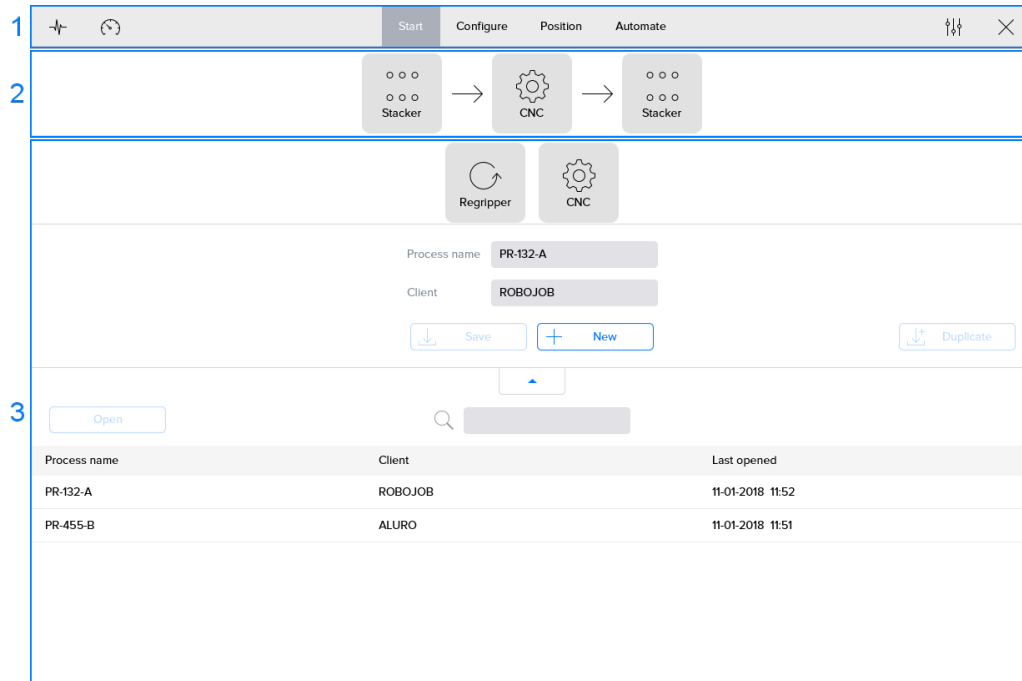

Figure 3.1. Screen layout

3.1.1. Main menu

The main menu is used to navigate between the four parts of setting up an automation process. Additionally, the alarms pop-up and robot pop-up can be shown. When a configuration error occurs while setting up the automation process, a corresponding warning message will be shown in this part of the screen.

Alarms menu

When clicking the alarm button, a pop-up shows the status of all connected devices. If an alarm is present, the button is highlighted in red.



Figure 3.2. Alarm button

The pop-up contains a section for each device. For each device the following information is shown:

- An indicator showing the status:
 - OK
 - Alarm present
 - Not connected
- The name of the device
- A reset button, used to reset the active alarms
- A list with all active alarms. For a description for each alarm consult [Appendix A: List of alarms](#).

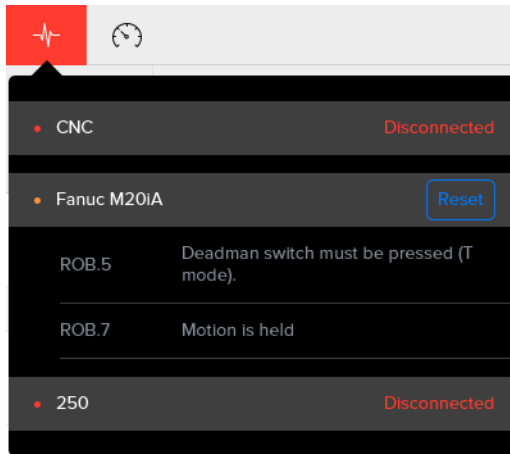



Figure 3.3. Alarms pop-up

Robot menu

The robot menu contains a list of robot-related actions and is indicated with the symbol . The following actions are present:

- Change the robot speed between 5% and 100%.
- Send the robot to its home: the robot will follow the reversed path which he used to reached the current position.
- Restart the software running on the robot.
- Open a gripper.
- Close a gripper.
- Send the robot to its gripper-change position to change a jaw.

Please note that during automatic process execution it is only possible to change the robot speed. The other actions are disabled, as they could possibly interfere with the automation process.

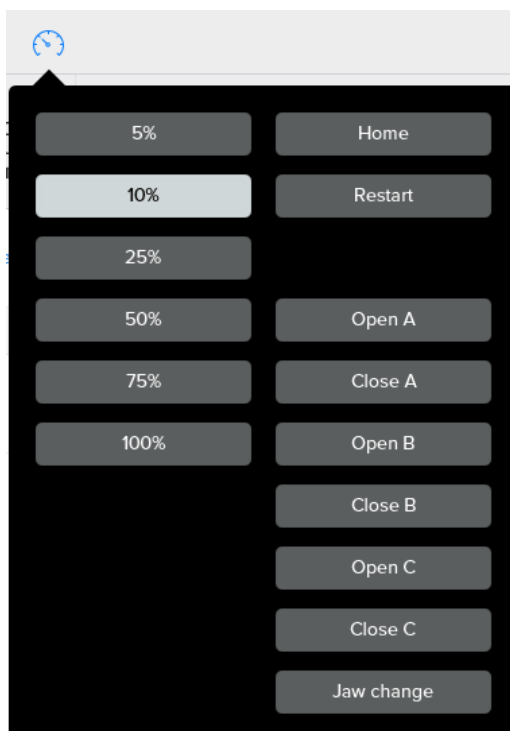

Figure 3.4. Robot pop-up

Configuration errors

If something is misconfigured, the software indicates this by showing a red circular icon in the main menu, this is the error icon. This icon indicates the amount of configuration errors. More information about these errors can be viewed by clicking on it. A message will be shown giving a brief description of what went wrong. If multiple errors are present, it is possible to navigate through all error messages using the arrows on the right. This information overlay can be minimized by clicking on the error icon.

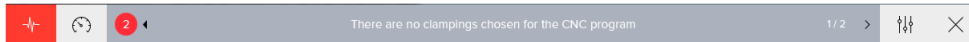

Figure 3.5. Configuration errors overlay

Furthermore, the navigation of the software will indicate where configuration errors occur. For example, in the image below, it is not possible to continue to the 'Position' section of the software, as there are still errors in the 'Configuration' part. The errors occur in the 'Workpiece' configuration. Both the raw and finished workpiece are misconfigured.

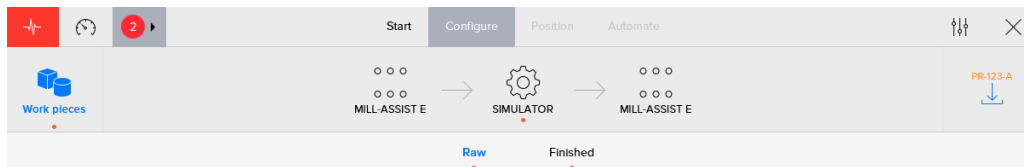

Figure 3.6. Error indicators

3.2. Start

This section of the software is always active after start-up. It has two main parts:

1. Configure the structure of the currently active automation process. It is possible to change the devices that are used and the steps the workpiece will need to go through. Additionally, the process name together with an optional client indicator can be entered.
2. A list of the last-opened processes is shown. This overview can be expanded and it is possible to browse through all previously-saved processes. Processes can be searched, opened and deleted.

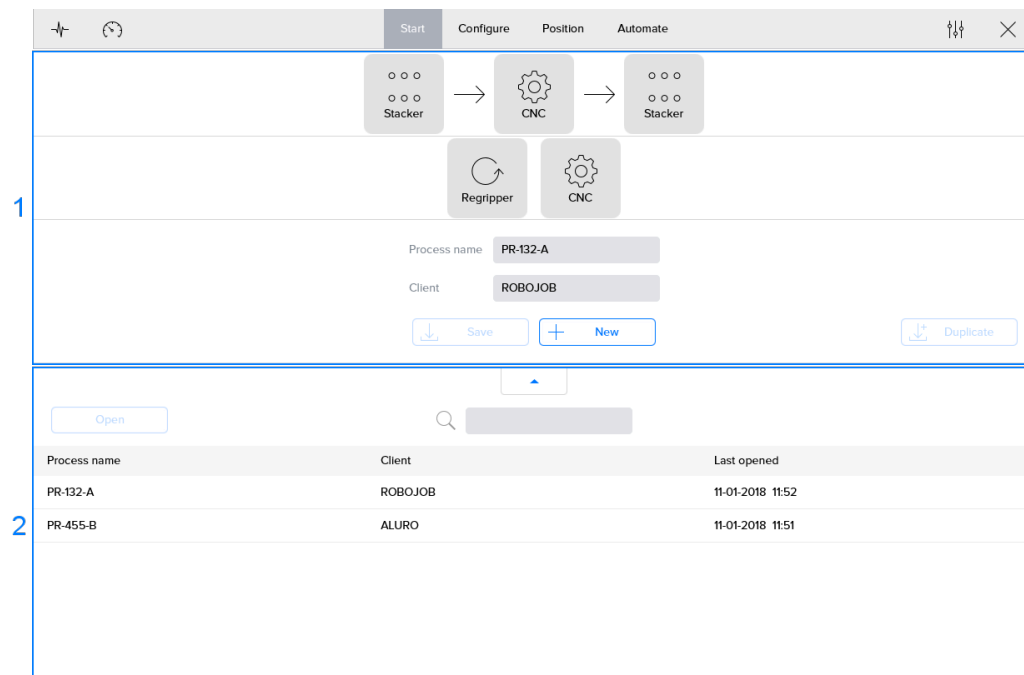

Figure 3.7. Start layout

3.2.1. Active process

In the top part of the screen, the active process automation is visualized. Right below, a list of the extra devices that can be used, is shown. Just drag one of these devices into the flow to include it. While dragging, the automation visualization indicates where the device can be dropped to be included.

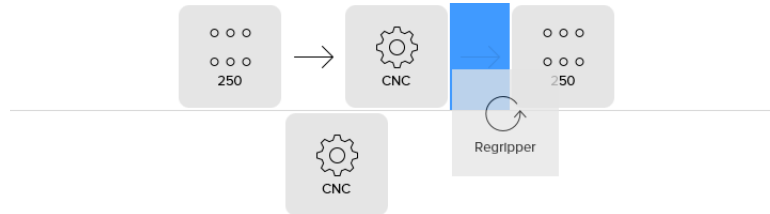

Figure 3.8. Add device to automation process

Similarly, any device that is in the active process can be dragged out. If the device can be removed, it can be dropped in the part containing the extra devices.

Please note not all devices can be removed. At all times at least one CNC device should be present. The process must begin and end with a stacking device.

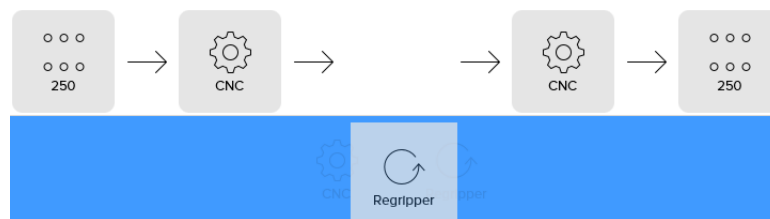







Figure 3.9. Remove device from automation process

List of devices

All possible devices are listed below together with a description of their functions. Depending on the used system, other devices can or can not be implemented in the automation process.

Symbol	Description
	The stacker is used as a support system for raw and finished workpieces. Different types of stackers can be used as already explained in Section 2.1.1, "Stacking devices" .
	Shaft rack
	Studs can be placed on a load pallet to position the workpieces accurately. It can be used to stack raw or finished workpieces.
	The used CNC-machine should be integrated to actually process the workpieces.
	A revolving unit is used for gripping a workpiece in a different orientation.
	A wooden pallet is mostly only used to stack finished workpieces. The locations of the workpieces are less accurate and so more suitable for finished workpieces.

Symbol	Description
	Finished workpieces can be dropped in a bin. So a bin can only be used at the end of the process.

Table 3.1. List of possible devices

Saving processes

Each process has to have a unique name and can have an optional client name. Changes to the process can be saved or a new process can be created. There are three buttons:

- **Save:** All process data is saved, overwriting the previously stored data. The button is disabled if no data has changed.
- **New:** A new process is created based on the current process. After creating a new process a new and unique name has to be entered.
- **Duplicate:** An exact copy of the process is saved. This button becomes available when the name of the process is changed. The original process stays unchanged and a copy is saved with the new name.

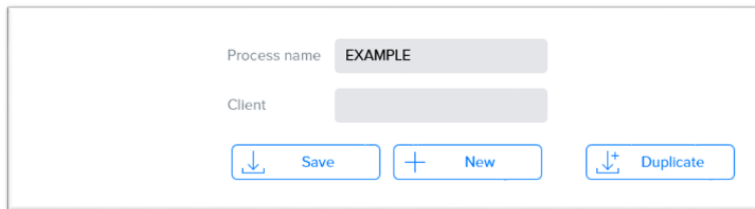
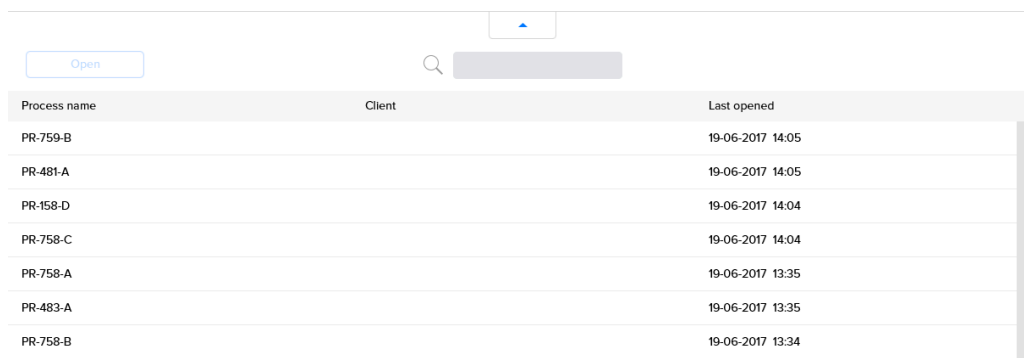

Figure 3.10. Naming and saving processes

3.2.2. Process management

The bottom part of the screen shows a list containing the saved processes. This part of the screen can be enlarged by clicking the button with an arrow up. When enlarged, the same button with an arrow down can be used to restore the size. For each process the process name, client name and last opened time is shown. By default the list is sorted by last opened time with the most recent on top. Click on the header to sort the list according to the column's values or flip the sorting direction.



Process name	Client	Last opened
PR-759-B		19-06-2017 14:05
PR-481-A		19-06-2017 14:05
PR-158-D		19-06-2017 14:04
PR-758-C		19-06-2017 14:04
PR-758-A		19-06-2017 13:35
PR-483-A		19-06-2017 13:35
PR-758-B		19-06-2017 13:34

Figure 3.11. List of processes

The search box can be used to search processes. After selecting a process, it can be loaded by clicking the 'Open' button. The 'New' button can be used to create a new automation process.

After enlarging the list of processes, an extra 'Manage' button is shown. After clicking this button, one or more processes can be selected. The 'Delete' button can then be used to delete the selected processes.

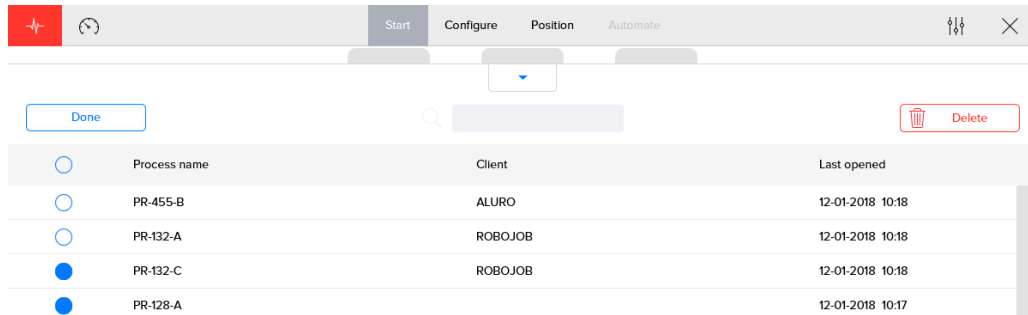

Figure 3.12. Select and delete processes

3.3. Configure

In this section, workpiece data can be entered and each device can be configured. The process part of this section acts as a secondary navigation and consists of the following parts:

- **Workpieces:** A button to activate the section where workpiece data can be set.
- **Automation process:** Each device can be selected, so its corresponding parameters can be set. Note the transport actions, the arrows, are greyed out and cannot be selected in this step.
- **Save**

3.3.1. Workpieces

In this section, all workpiece-related data is entered. At the top part of this section, users can navigate through the different workpiece types. A raw and finished workpiece should always be configured. If the revolving unit is also used, also a half-finished workpiece needs to be set-up. Each of these workpiece types is identified with a color. These colors are used throughout all workpiece visualizations:

- Orange: raw workpiece
- Yellow: half-finished workpiece, not always necessary
- Green: finished workpiece

The visualization can be rotated by dragging. Zooming is possible by using the zoom buttons, or by using the two-finger pinch-to-zoom gesture. Additionally, a specific view can be selected: front, top, left, 3D.

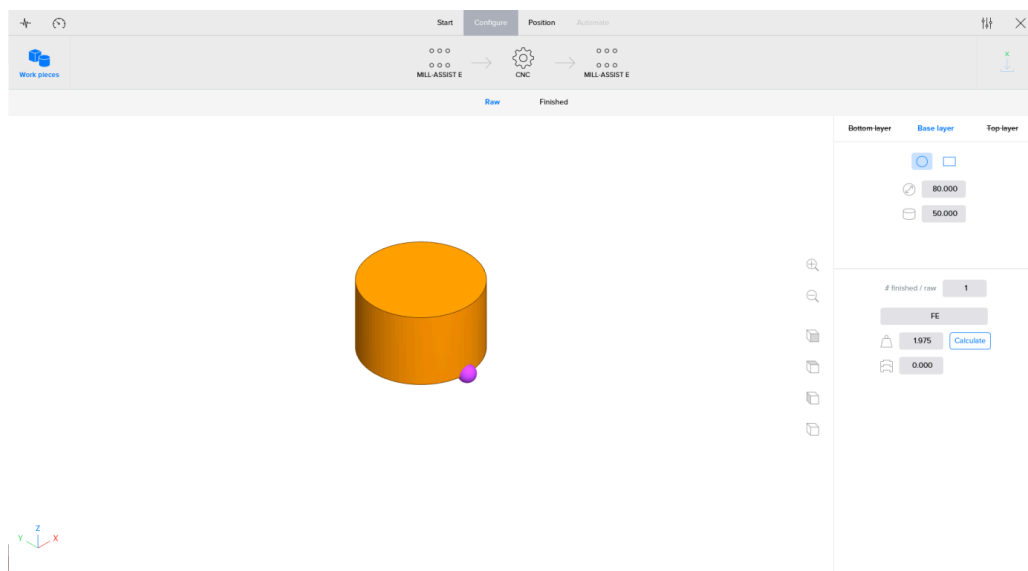

Figure 3.13. Workpiece screen with circular base shape

Layers

The dimensions of each workpiece can be entered by using at most three layers: base, bottom layer and top layer. The base layer defines the form of the workpiece and how the workpieces are positioned on the stacking devices. The shape should be a rough representation of the outer form used for positioning, gripping with the robot and clamping in the machine. For simple workpieces, only using the base shape should be sufficient for describing the workpiece.

For more complex workpieces there is the possibility to add a top or a bottom layer. The top and the bottom layers can have a different form and dimensions than the main shape. These top or bottom layers can later be selected as reference for gripping with the robot or clamping in the machine in the positioning step. Adding a top or bottom layer will make it easier to position complex workpieces. The software will use the top and bottom layers to suggest the correct grippers and gripper positions to handle the workpiece.

The system with base, top and bottom layers is not intended to make an exact representation for the workpieces, but are there to give the necessary dimensions to position the workpieces on the stacking devices, grip the workpieces with the robot and clamp the workpieces in the machine. Only functional layers should be added to the representation.

For each layer a shape can be chosen, circle or rectangle, and relevant dimensions can be entered. For a circular shape the diameter and height should be given and for a rectangular shape the length, width and height are needed. The length should always be longer than the width.

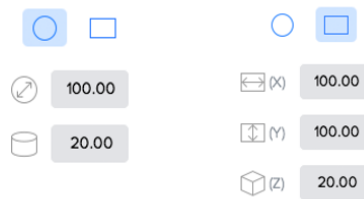

Figure 3.14. Shape input fields for circular (left) and rectangular (right) shapes

For the top and bottom layer, a user can select if the shape is unused, subtracted from the base layer or added to it. Additionally, extra input fields are present to position the layer relative to the base layer. The coordinate axes shown in the workpiece visualization correspond to the ΔX and ΔY input fields. The ΔR input field can be used to rotate the layer around the Z axis. The reference for positioning is the center of the base shape.

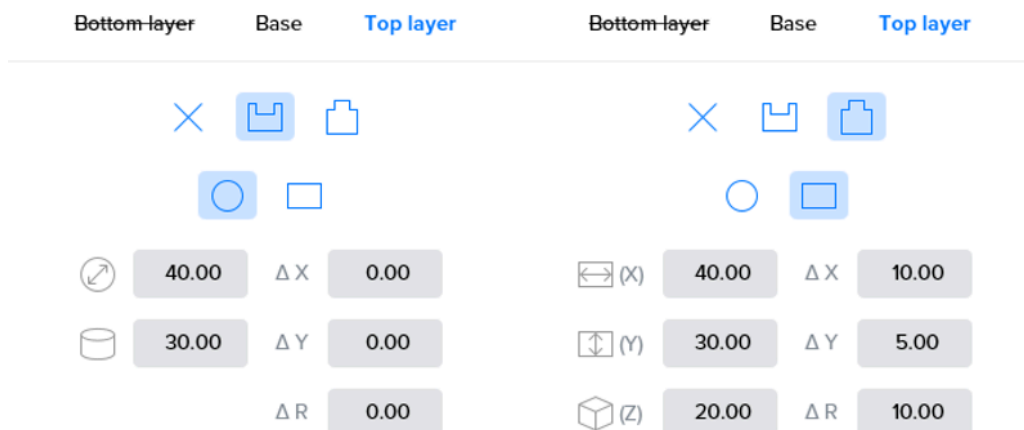

Figure 3.15. Adjust top layer

The bottom layer can be adjusted in the same way as the top layer. If a top or bottom layer is not present, the layer name will be crossed out.

The base layer boundaries are used as reference for positioning the workpiece on the stacking device. It is recommended that the top or bottom layer do not exceed the boundaries defined by the base layer, as these boundaries are not taken into account for positioning the workpiece.

Specifications

Other specifications like material can also be defined in this step of the configuration.

In the bottom-right part of the 'Workpieces' screen, the number of finished pieces out of one raw workpiece can be defined. When a large raw workpiece is used, it can be possible to create multiple finished workpieces out of one. The amount of finished workpieces from one raw workpiece indicates how many times the robot should unload a finished workpiece, before loading a new raw workpiece.

finished / raw

Figure 3.16. Number of finished workpieces

Below the number of finished workpieces, the workpiece material can be chosen: Al, Cu, Fe or other. Also the weight can be entered. Depending on the dimensions of the workpiece and the chosen material, the weight can be calculated automatically. Note that changing the workpiece dimensions triggers an automatic weight calculation.

AL

Figure 3.17. Workpiece weight

The text-field in the bottom can be used to indicate how far workpieces overlap when they are stacked on each other. In this way the device can calculate the total height of the workpieces. Therefore it is very important to enter this value correctly, as it influences the height where the workpieces are gripped.



Figure 3.18. Workpiece overlap

3.3.2. Devices

Stacking and processing devices sometimes need additional configuration. Below the configuration screens for each of these devices are described. Note that only the installed devices will be available for an installation.

Essential stacker

The essential stacker configuration screen shows how the raw or finished workpieces will be placed on the stacker plate and where the support studs and optionally workpiece alignment corners need to be positioned.

On the top right the maximum capacity for the current configuration is indicated. During the automation step it is possible to select the actual amount of workpieces that need to be produced.

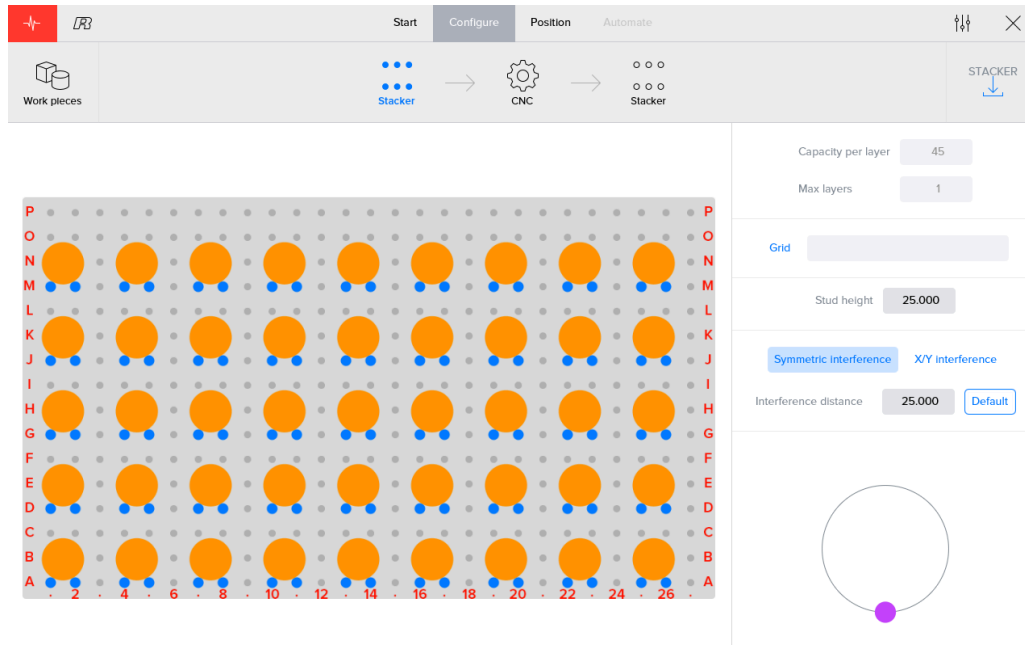

Figure 3.19. Essential stacker with raw circular workpieces

Below, the user can indicate whether or not a grid will be used. Initially, no grids will be present as most workpieces can be stacked using the provided studs and workpiece alignment corners. However, grid configurations can easily be added. Grids can be created and adjusted in the admin menu, as will be further explained in [Grids](#). When grid is activated, it is possible to select a grid from the menu. The definition of the grid will define how many layers of workpieces can be stacked.

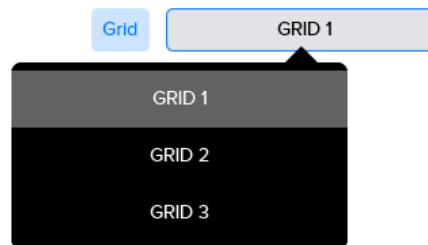

Figure 3.20. Grid selection

If a grid is used, the origin of the grid can be entered. The origin is the location of the bottom-left coordinate of the grid, relative to the bottom-left coordinate of the stacking table. Also the extra height above the grid used for stacking can be entered.

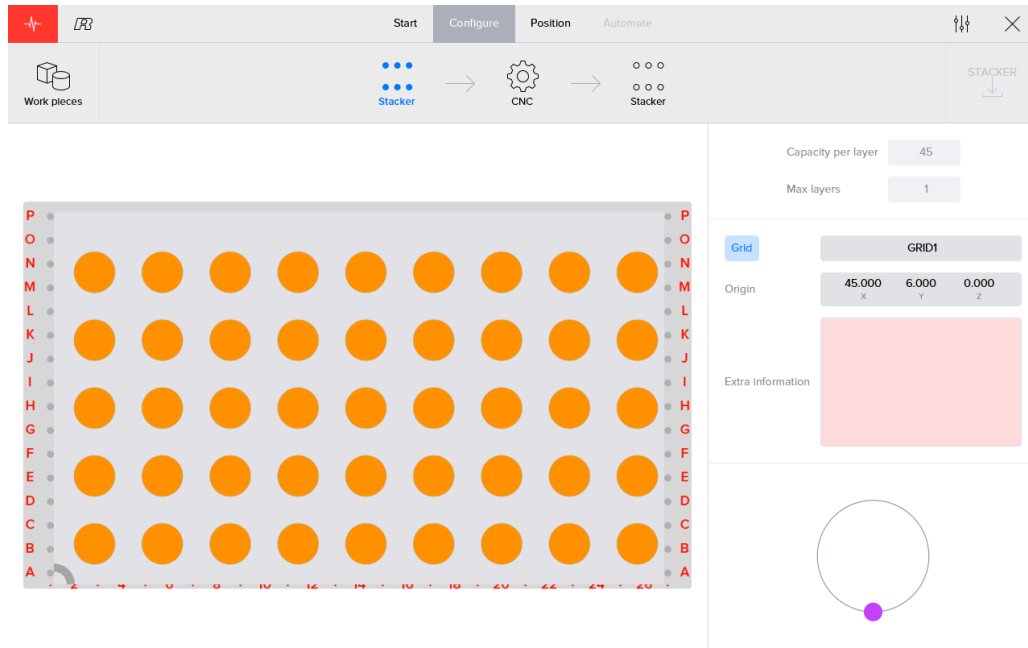

Figure 3.21. Essential stacker with grid for round workpieces

The software will calculate how many layers of workpieces can be stacked based on the workpiece height and the stud height. Studs of different heights are available, the total stud height has to be entered.

Please note the maximum number of layers depends on the height of the workpiece and the stud height, without grid, or extra stacking height, with grid.

Stud height

Figure 3.22. Stud height

Changing the interference distance will result in more or less clearance between the workpieces on the stacker.

Make sure to take into account the width and stroke of the used gripper when changing the interference distance.

Interference distance

Figure 3.23. Interference distance

In the bottom-right of the screen a top-view of the workpiece shows how the workpieces should be oriented in their stacking positions. This orientation is particularly relevant if an asymmetrical shape was entered, i.e. a shifted top or bottom layer. The purple dot indicates the reference of the workpiece.

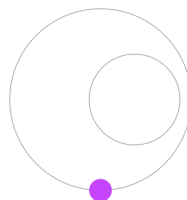

Figure 3.24. Top-view stacking orientation circular workpiece

Stacker

Different sizes and capacities are possible using the different stackers explained in [Stacking devices](#). Configurations for raw (orange) and finished (green) workpieces are shown below.

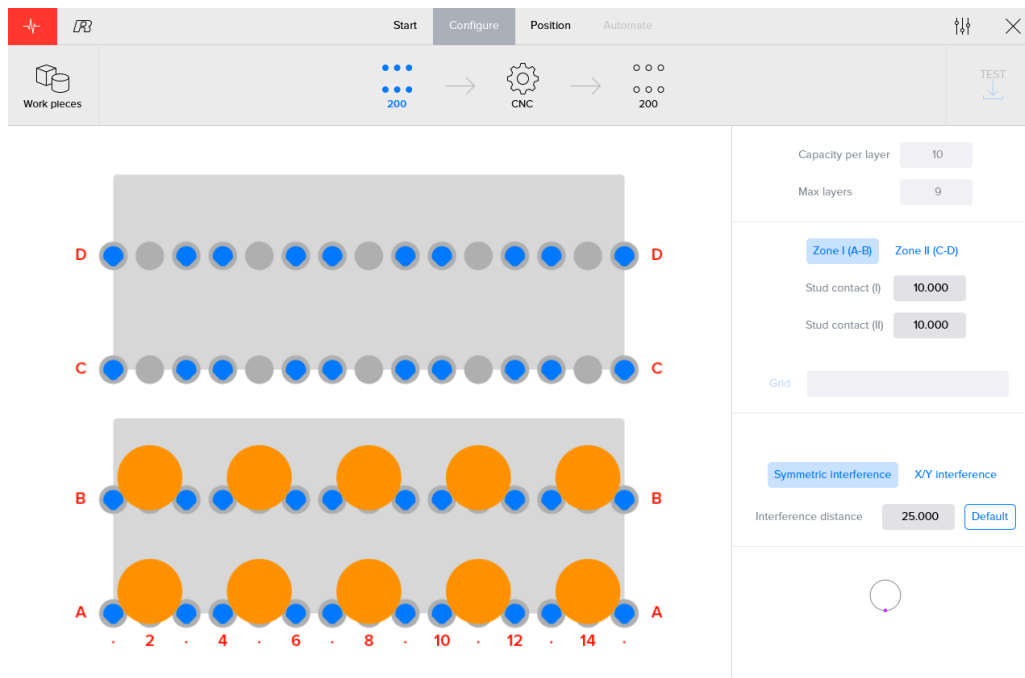

Figure 3.25. Stacker with raw workpieces

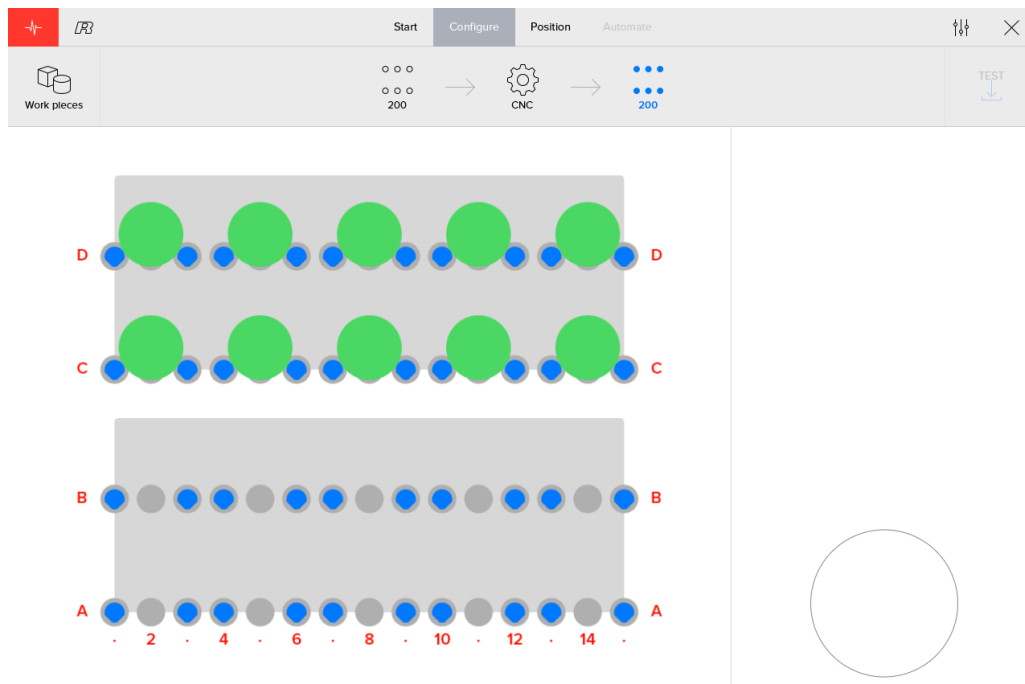

Figure 3.26. Stacker with finished workpieces

As with the essential stacker, the maximum amount of workpieces are displayed in the top right. During the automation step it is possible to select the actual amount of workpieces that need to be produced.

Underneath the maximum capacity the stacker zone can be selected. Both zones can be used when raw or finished workpieces come from or go to another stacking device.

Changing the interference distance will result in more or less clearance between the workpieces on the stacker.

Make sure to take into account the width and stroke of the used gripper when changing the interference distance.

The stud contact is the height that the support pillars have relative to the bottom of the workpieces in the top layer of workpieces. The table will always move after a layer is finished. The contact height can be set separately for raw and finished workpieces.

Zone I (A-B) Zone II (C-D)

Interference distance 10.000 Default

Stud contact (I) 10.000

Stud contact (II) 10.000

Figure 3.27. Stacker configuration

The stacker tables can be moved to the height of the maximum capacity. The stacker support pillars can be clamped or unclamped to add or remove the pillars.

Watch out that workpieces do not fall of the stacker when moving the stack plates.

Zone I -250.000 > -330.000

Zone II -10.000 > -10.000

Stacker to start position Stop

Figure 3.28. Moving stacker tables to the maximum capacity height

CNC machine

Workpieces are hold in place in the machine by different types of clamping systems or fixtures. Often it is possible to change the clamping system in a machine.

Turning machines will have one or two rotating spindles.

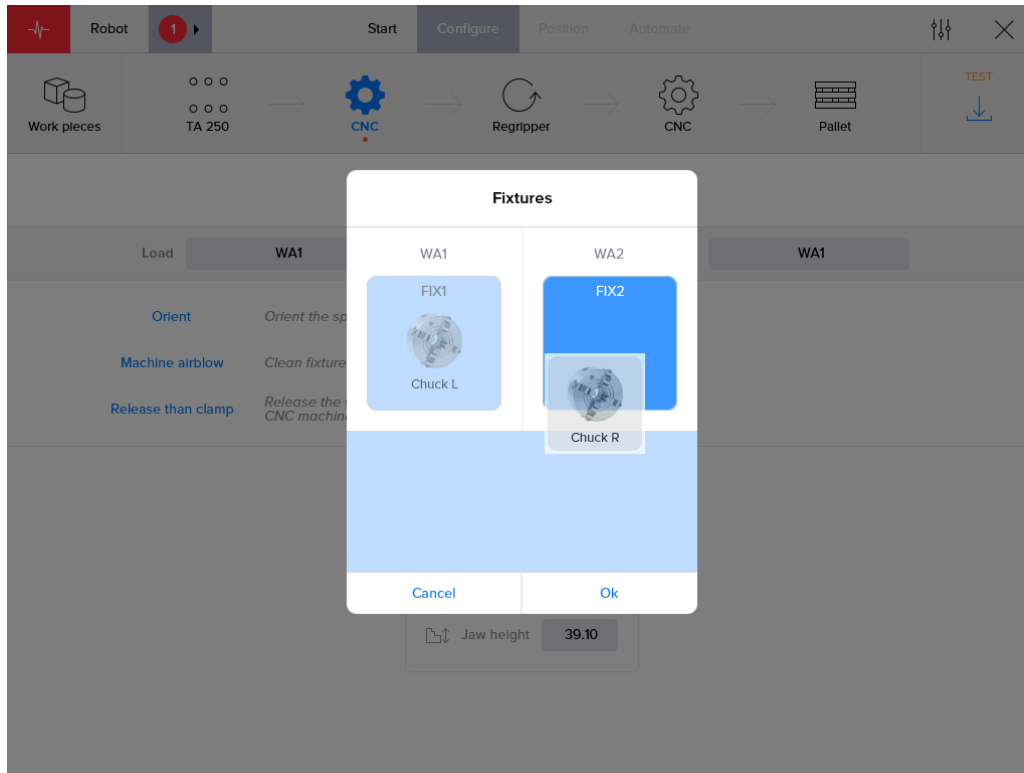

Figure 3.29. Configuration of fixtures for a turning machine

In the software it is possible to define multiple fixtures. In the configuration step it is possible to select the fixture that will be used to process the workpiece. When clicking on the 'Fixtures' button a pop-over is shown in which fixtures can be assigned to fixture positions. Which fixtures are used on which positions can be changed by dragging fixtures to the correct position. Depending on the type of machine, turning or milling, and physical layout of the machine one or more fixture positions will be available.

After configuring the fixtures in the work areas, it is possible to select which work area can be used for loading and unloading workpieces.



Figure 3.30. Work area selection

One or more fixtures can be selected in a work area, but at least one has to be selected. The selected fixtures, highlighted in blue, will be used in the automation process.

For each fixture the jaw height can be entered. Make sure to enter a correct jaw height, as it will be taken into account when positioning workpieces in the CNC machine.

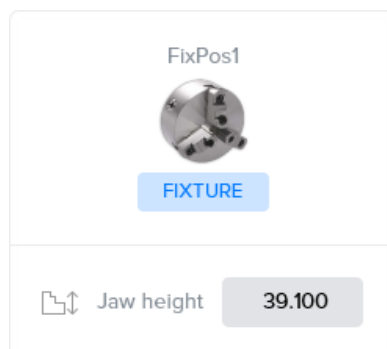

Figure 3.31. Jaw height for fixtures for turning machines

Depending on the options provided by the CNC machine, the following additional settings may be present:

In the case of two grippers the option **'Turn in machine'** can be enabled. When the machine is large enough, the robot can rotate his grippers in the machine. In this case the robot will remove the finished workpiece with gripper A, rotate the grippers in the machine and put the next raw workpiece into the CNC-machine using gripper B. In case of a small machine, the turning should be executed outside the CNC-machine.

Another option is to perform a **single cycle**. When the robot has two grippers, A and B, it is possible to grip the next raw workpiece with gripper A before removing the finished workpiece of the CNC-machine with gripper B. In case of 'Single cycle' the robot will not take a new raw workpiece before the current workpiece is being removed of the CNC-machine. Because the execution time is reduced when combining multiple are combined, 'Single cycle' is disabled by default.

For loading the option **'Release than clamp'** can be enabled. When this setting is enabled, the robot will release the workpiece before the machine clamps it. When using a spring pressure system this option is required, because the spring will push the workpiece into the chucks during releasing. If the workpiece is already clamped, the spring will have no effect.

- **Machine airflow:** enable/disable the machine airflow for loading/unloading.
- **Orient:** orient the spindle before loading/unloading.

Revolving unit for a Turn-Assist

The configuration width is the configured position of the revolving unit.

Next, the height of the studs can be entered.

This value will not be calculated automatically. It should be filled in depending on how the revolving unit should be configured. It is up to the user to determine the best position.

Finally, the orientation for loading and unloading can be selected. Typically workpieces will be put on the revolving unit from the bottom (Down), and picked from the top (Up), but this can be changed. That loading and unloading should occur in different orientations, otherwise the revolving unit will have no effect.

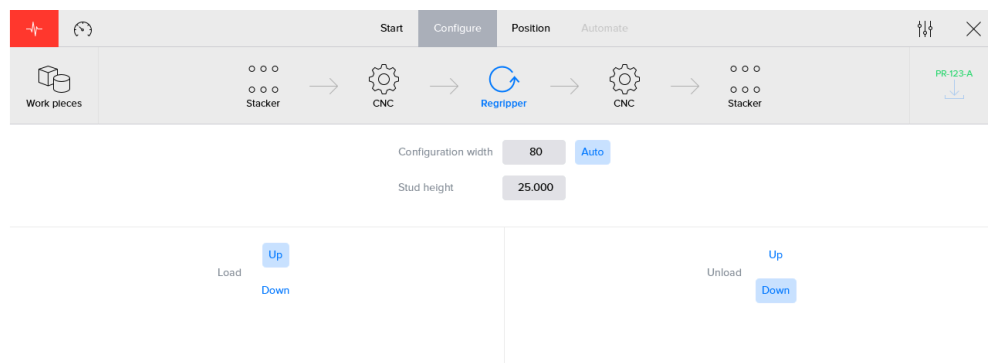

Figure 3.32. Configuration of a revolving unit

3.3.3. Save button

On the right of the automation process navigation, a save button is present. This button indicates the process name and can be used to save all process data. If the process name is shown in orange, the process contains unsaved data. After saving, the color changes to green and the button is disabled, to indicate saving is no longer needed.

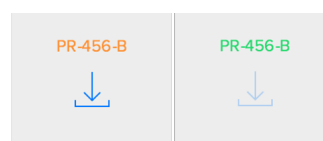

Figure 3.33. Save button

3.4. Position

In this section, the exact locations for picking and putting workpieces are manipulated. The automation process on the top of the screen acts as a secondary navigation. By clicking the arrow icons, the corresponding robot transport actions can be configured. Additionally, the following extra buttons are present:

- **Teach** (left): A button to activate a guided walkthrough
- **Save** (right)

3.4.1. Transport actions

In this section, all position related data can be set. In the top part of this section, users can navigate through the two parts of each transport action:

- **Pick**: picking up a workpiece from a device
- **Put**: placing that workpiece in or on a device

The visualization can be rotated by dragging. Zooming is possible by using the zoom buttons, or by using the two-finger pinch-to-zoom gesture. Additionally, a specific view can be selected: front, top, left, 3D .

To give a clear overview of the effect of the entered position data, the workpiece, robot jaws and part of the device are all shown in the visualization. With this overview each part can be adjusted immediate visual feedback on screen. The user can for example check and adjust when a gripper collides with a stud while picking up a workpiece.

The right part of the screen can be used to edit position-related settings. These settings can also be subdivided into 4 categories:

- **Gripper** (only editable for Pick-actions): Edit which gripper and jaws will be used and how they are configured.
- **Position**: Edit the exact destination for picking/putting workpieces.
- **Smooth**: Edit the first retract from (pick) or final approach to (put) movement.
- **Airblow** (only for CNC-related actions): Configure the robot airblow movement.

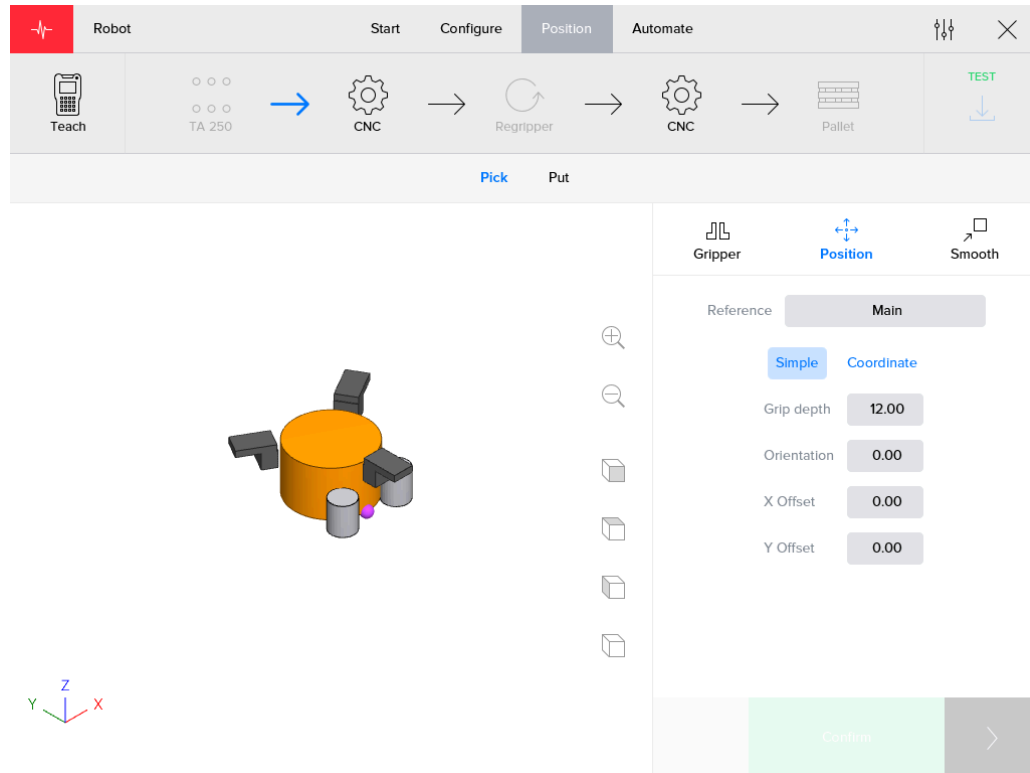

Figure 3.34. Position screen for circular workpieces

In the bottom-right of the screen the previous, confirm and next button can be found:

- Left: Go to the position details of the previous transport action (if available).
- Center: Confirm the entered position details. This button is disabled if the position details were already confirmed.
- Right: Go to the position details of the next transport action (if available).

Please note the position details for each step need to be confirmed before it is possible to continue to 'Automate'.

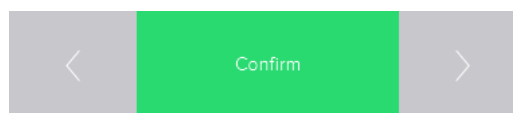

Figure 3.35. Position buttons

Gripper

In this section gripper details can be edited. Users can indicate which gripper should be used and how it should be configured. Throughout the section, checkmark icons indicate which configuration is currently active. The system remembers which grippers were last used, which jaws were attached and how they were configured.

Please note the gripper configuration part is only present for pick actions.

In the top part of the section users can select which gripper side (A or B) will be used for this specific transport action. After clicking on the 'Configure' button, users can indicate which gripper is attached to which side and which jaw set is used.

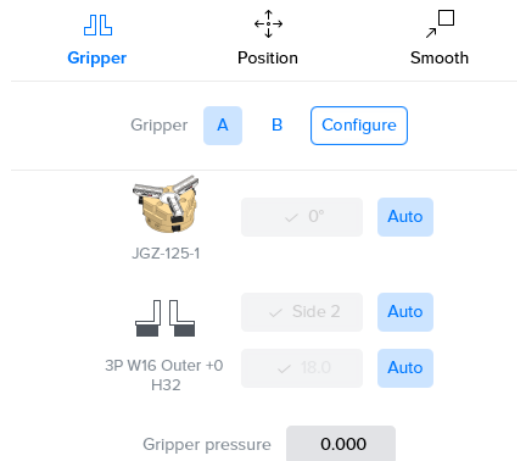

Figure 3.36. Gripper part of the position screen: 3 point grippers

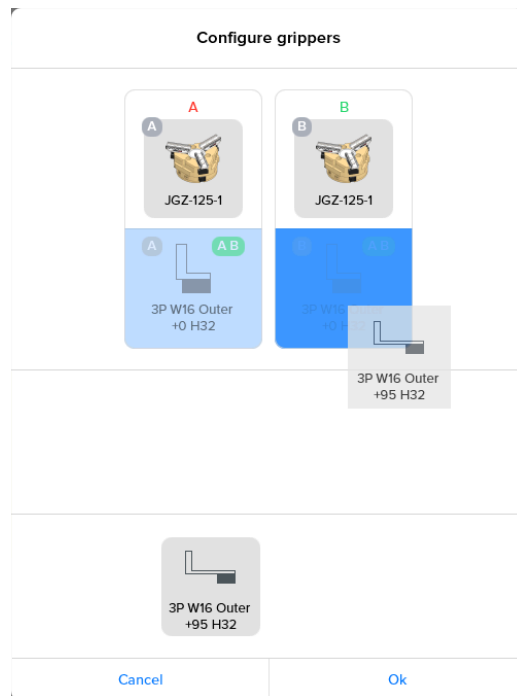

Figure 3.37. Configure grippers: 3 point grippers

After configuring which grippers and jaws will be used, the actual gripper configuration details can be edited. Note that for most settings, an 'Auto' toggle button is available. In case this 'Auto' button is selected, the software platform will calculate the best option. By deselecting 'Auto', users choose to manually override the settings. The following settings need to be configured:

- **0° or 90°:** The way the gripper is positioned on the gripper body in degrees. Depending on the type of gripper system present at your installation only one of these options may be present.
- **Side1 or Side2:** The way the jaw is positioned on the gripper.
- **Jaw location:** The position of the jaws.

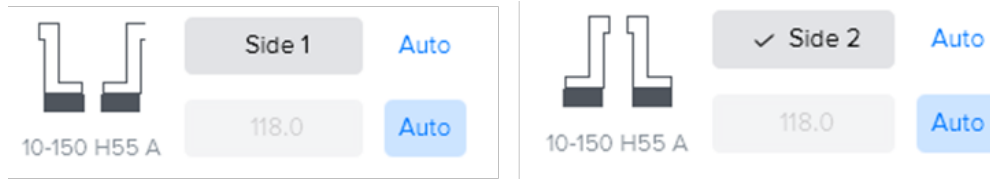

Figure 3.38. Side1 (inner) or Side2 (outer) jaws

Position

The position will define how the grippers or workpiece will be positioned with respect to the workpiece, clamping system or stacking location. The following settings need to be configured:

- **Reference:** The layer used as a reference for positioning. The list of layers to choose from corresponds to the layers enabled when configuring the workpieces.
 - For pick actions, the positioning data entered will position the bottom of the gripper jaws relative to the top of the selected layer.
 - For put actions, the position data will position the bottom of the selected layer relative to the clamping system or stacking location. In this case an extra 'Workpiece' option is present. This layer has the same reference as the main layer, but translated to the bottom of the total workpiece. It is therefore very useful when positioning put actions for workpieces with multiple layers.

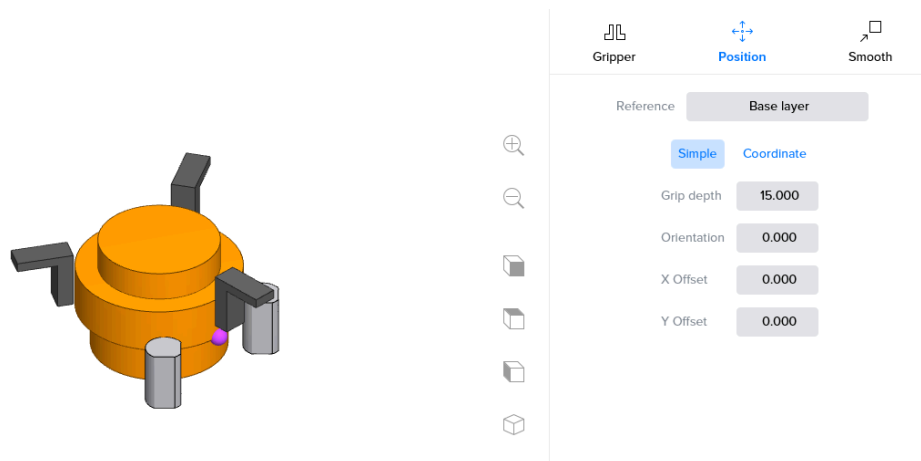

Figure 3.39. Example of picking on base layer (circular workpiece)

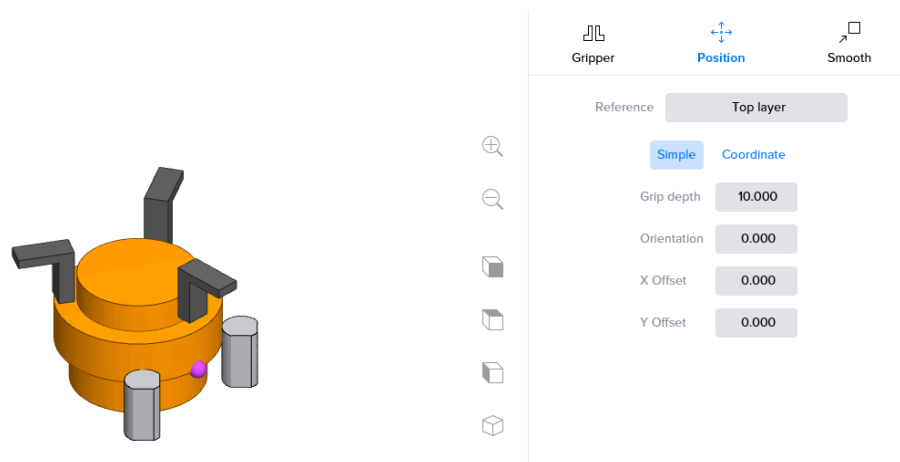

Figure 3.40. Example of picking on top layer (circular workpiece)

- **Simple or advanced coordinates:** Input fields with the actual coordinates are used for positioning relative to the chosen reference. Note that the values entered will be applied to the chosen reference and correspond to the coordinate system shown in the visualization.

- Simple shows only the most relevant input fields.
- With the coordinate input fields the actual position of the gripper or workpiece can be changed. Coordinate shows all input fields for advanced positioning.

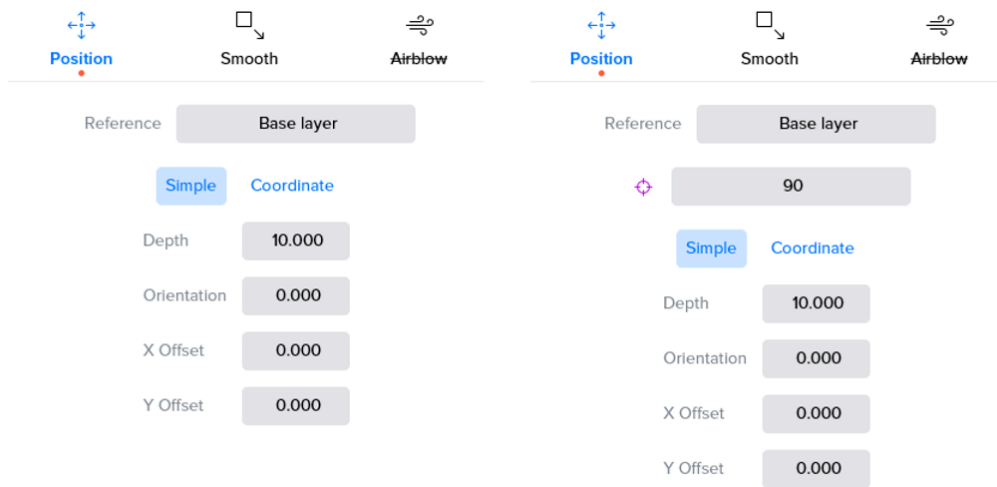

Figure 3.41. Position configuration menu

Another possibility is to grip the workpiece on the inside. This is only possible when a cutout in the toplayer is present. Internal gripping can be selected in the position menu by choosing the top layer as the reference for the grippers.

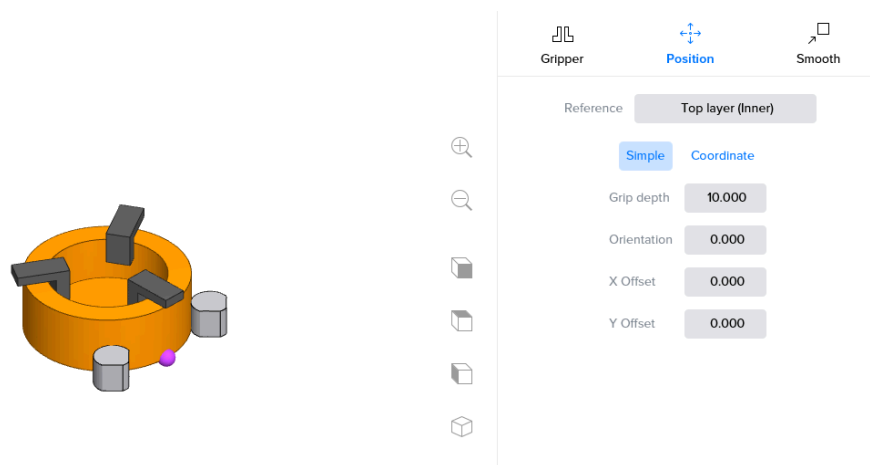

Figure 3.42. Internal gripping of a circular workpiece

Note that in some cases a workpiece can not be positioned. This is due to the constraints of the robot and the positioning of the previous step(s).

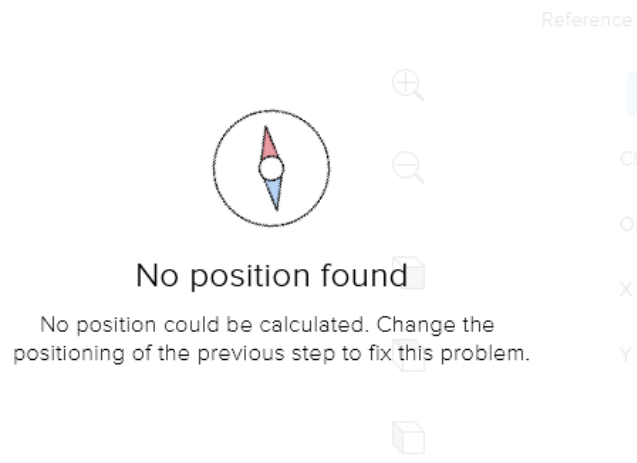

Figure 3.43. No positioning possible

Smooth

The smooth part of the position screen allows the user to configure an approach to (for a put) or retract from (for a pick) strategy. A position is entered, relative to the final destination and corresponding to the coordinate system shown in the visualization.

For a pick action with a smooth defined as X: 1, Y: 2, Z: 3, the robot will pick up the workpiece and instead of simply moving away in the z-direction, it will first move simultaneously 1mm in the X-direction, 2mm in the Y-direction and 3mm in the Z-direction in. Afterwards, it will move upwards to a safe Z location and move away.

For a put action with a smooth defined as X: 1, Y: 2, Z: 3, the robot will move simultaneously to a position that is 1mm in X, 2mm in Y and 3mm in Z from the destination before moving linearly towards it.

The smooth configuration screen for put actions also has the option to configure the robot to push in a certain direction. This can be necessary to position the workpiece more precisely. The difference between these positions and adjusting the real position of the workpiece is that the pushing directions have no influence on the position of the workpiece for the gripper in further steps. [Table 3.2, "Smooth symbols"](#) explains all possible directions.

Symbol	Description
↑	Leaving a gap of 1 mm between workpiece and the device.
-	No pushing
↓	Pushing 1 mm towards the device.
⇓	Pushing 2 mm towards the device.

Table 3.2. Smooth symbols

When reset is pushed, the default smooth values will be used. These default values are pre-defined by the RoboJob installation team.

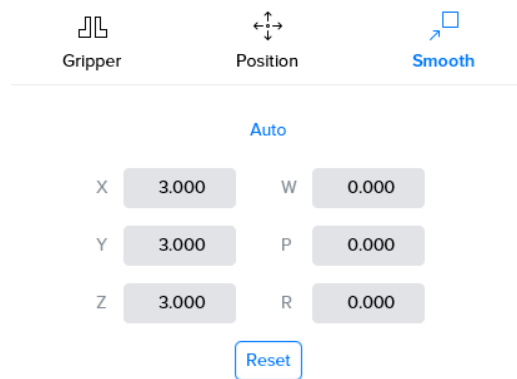

Figure 3.44. Smooth configuration for a put action

Airblow

For pick or put actions from or on a CNC machine, a robot airblow can be configured. This robot airblow describes the path the robot will move to clean the workpiece, for a pick, or to clean the fixture, for a put. Different options are available for describing this movement.

- **Auto:** The system will calculate the path automatically. For a put action, the fixture will be cleaned. For a pick action, the contour of the workpiece will be used. It is possible to define how far the path will be located from the reference and for how many iterations the path will be travelled. Auto has an extra option 'Jog spindle' so the spindle keeps rotating after removing the workpiece in order to remove all remaining chips on the spindle.
- **Circular:** The robot will follow a circular path with a certain diameter.
- **Rectangular:** The robot will follow a rectangular path with a certain length and width.
- **Polygon:** Users can define a self-defined path. It is possible to define lines on which the robot will blow and lines on which the robot will not blow. The lines with airblow will be shown in the visualization. Note the given points can be managed using the 'Manage points' button.
- **No airblow:** Default value where no airblow cycle is done.

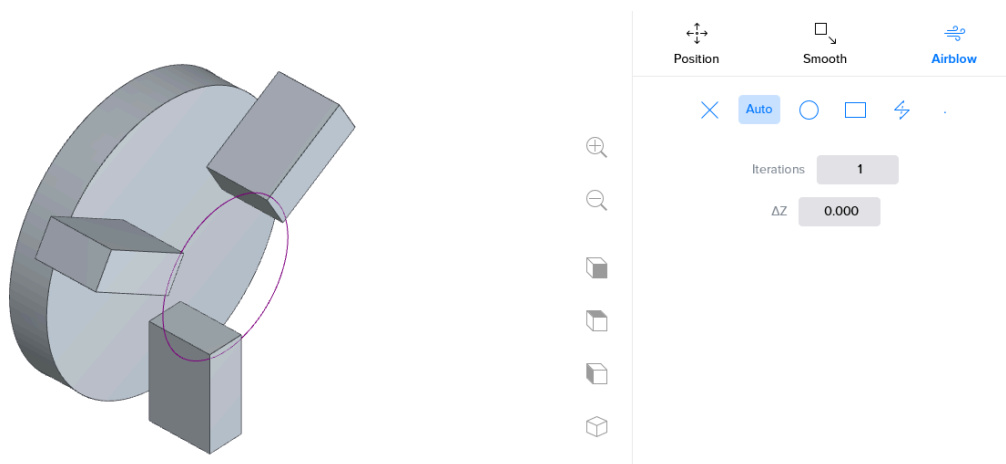
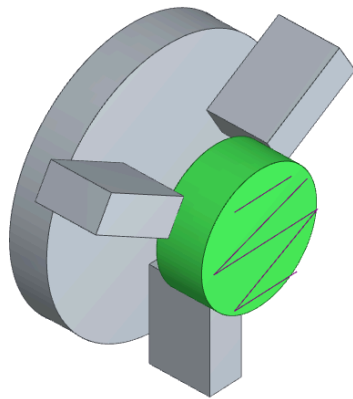

Figure 3.45. Robot airblow menu for 'auto' for a turning machine



Gripper				Position				Smooth				Airblow			
Auto				Iterations: 2				Manage points							
X	Y	Z		X	Y	Z		X	Y	Z		X	Y	Z	
-30.0	40.0	90.0		25.0	40.0	90.0		40.0	30.0	90.0		-50.0	0.0	90.0	

Figure 3.46. Robot airblow menu for 'polygon' for a turning machine

3.4.2. Teaching

Overview

Teaching can be seen as guiding the robot through the entire automation process. When teaching, the robot will be able to perform the necessary movements between the various devices and to the workpieces automatically. Teaching is only required to specify how workpieces should be picked up or how they should be positioned.

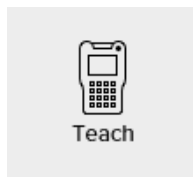
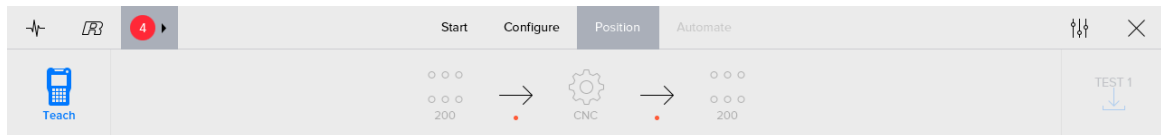

Figure 3.47. Teach button



Ready? Set? Go!

Make sure all grippers are configured as indicated below. The robot uses the confirmed positions. For all non-confirmed positions a safe value is used. Note that only 1 piece will be taught. This piece must be located at the first position of the inbound device.

Reset positions

<p>Zone I -250.000 > -250.000</p> <p>Zone II -10.000 > -10.000</p> <p>Stacker to start position</p> <p>Stop</p>	<p>A JGZ-125-1 3P W16 Outer +0 H32 11.0</p> <p>B JGZ-125-1 3P W16 Outer +0 H32 18.0</p> <p>Robot to jaw change position</p>
-----------------------------------------------------------------------------------------------------------------------	-----------------------------------------------------------------------------------------------------------------------------



Figure 3.48. Teach overview (3 point grippers)

Preparation

The teaching process can only start if no errors are present, all needed devices are connected and the robot is in T1 mode. The Teach Pendant should be switched on with the switch at the top left. Once this is taken care of, the Start button is enabled and teaching can start.

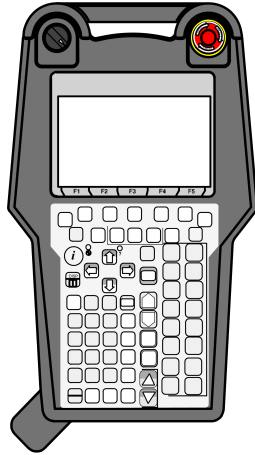

Figure 3.49. Enable switch on the Teach Pendant

When a user presses the teach button, an overview of the selected grippers and their respective settings is shown. Users need to make sure all grippers are configured correctly. If this is not the case, the robot can be sent to its jaw change position so the grippers and jaws can easily be altered.

Please note teaching will use all confirmed positions. This means that if some steps were confirmed, the robot will use the destination for these steps. If a position was not yet confirmed, the robot will move to a safe position above the pieces or fixtures and the teaching process starts from there.

The confirmation of all positions can be discarded by pressing the 'Reset positions' button. This will ensure teaching will start from a safe position for each step.

Execution

At the beginning of the teaching process, the robot will move to a position from which the destination can be taught. Please note movements towards this starting position happen automatically, but the Deadman switch should be pressed the entire time to allow robot motion (as already explained in **Safety**).

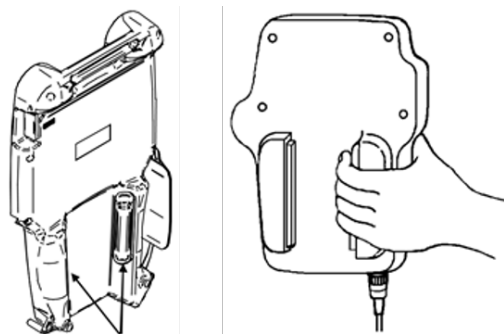

Figure 3.50. Deadman switches on the Teach Pendant

The interface on the IPC will indicate when the robot should be taught to the correct position. By using the teach pendant, the robot can be guided to the correct position. The speed controls on the teach pendant can be used to adjust the speed so that movement can be controlled very precisely. This can be particularly useful when the robot approaches the desired destination.

If necessary, the grippers can be opened and closed in order to verify the robot position.

If a correct destination is reached, this position can be confirmed using the SHIFT + STATUS button. After teaching all steps, the process can be started automatically in the 'Automate' section.



Please guide the robot to the desired position

Figure 3.51. User action required for teaching

Busy	Stop	Hold	Pause	AO_START LINE 0	T2	ABORTED	USER	100%
Run	I/O	Prod	Stop					

START [DESTINATION]
 CONF:N U T, 0, 0, 0
 X: 0.000 Y: 0.000 Z: 40.000
 W: 0.000 P: 0.000 R: 175.000

UF:6 UI:5

CURRENT CONF:F U T, 0, 0, 0
 X: 146.431 Y: 1190.254 Z: 513.931
 W: 168.335 P: -28.078 R: -112.141

USER	TOOL
------	------

Press + to confirm position

[TYPE]	BACK	FORWARD	REFRESH	HOME	>
----------	------	---------	---------	------	---

Figure 3.52. Teaching screen on the Teach Pendant

Controlling the robot

The robot can be moved manually using the Teach Pendant, this is called jogging the robot.

Make certain that all safety requirements for your workplace are followed before and while jogging the robot; otherwise, you could injure persons or damage equipment. The person holding the teach pendant is responsible for the movements of the robot when jogging manually.

The following buttons are relevant:

1. **Jog keys:** Moving the robot manually is called jogging the robot. The position of the robot can be controlled using the jog keys. The robot can be translated in the x-, y-, z-direction and rotated around the x-, y- and z-axis. Press and hold 'shift' before pressing a jog key.

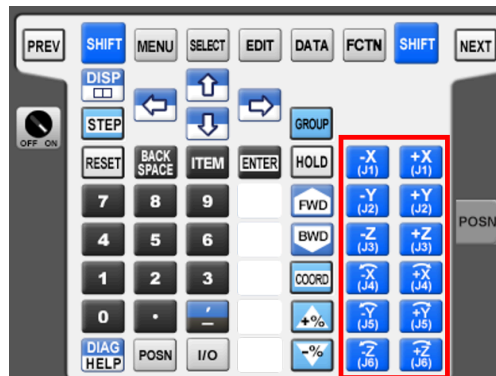

Figure 3.53. Jog keys

2. **Speed override keys:** The speed override that limits the robot movement speed can be adjusted using these controls.

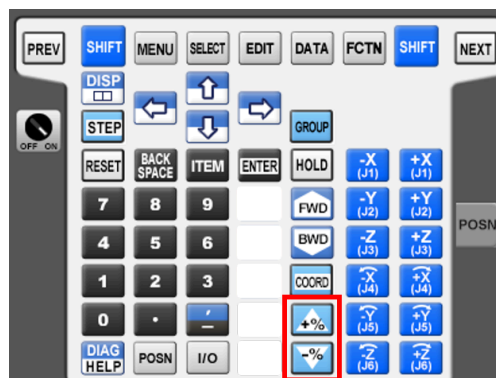

Figure 3.54. Speed override keys

3. **Tool keys:** These are the keys in the column under the 'Enter' key. Depending on the version of teach pendant these keys are blank or have text. Tool 1 is the key immediately under the enter key. Tool 5 is the last key at the bottom of the teach pendant.

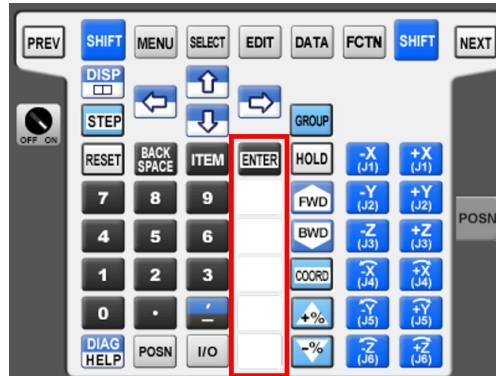

Figure 3.55. Enter and tool keys

4. **Shift key:** Used in combination with the jog or tool keys.



Figure 3.56. Shift key

It is extremely important for the teaching process that during the learning process, pieces do not move into the robot grippers. If this happens, it is necessary to abort the process and restart from the beginning.

3.5. Automate

After the process is configured without errors, it is possible to start the automation process in the automation step. The process flow on top of the screen can be used to configure interventions. The following components are part of the automate screen:

- **Status:** An overview of the status of the automation process is shown. The automation can only be started in this section. The amount of workpieces can be selected in this section.
- **Automation process:** The transport action buttons can be selected to configure manual interventions.
- **Layout:** Shows a live overview of the layout of the stacking devices during the process.

3.5.1. Status

Configure automation (1/2)

In this section, the number of raw pieces and layers can be entered. For both these values the maximum can be calculated automatically. In some cases, there are already finished workpieces on the stacker, therefore the number of finished pieces can also be entered.

A detailed layout is also available. This screen can be helpful to setup the stacker correctly or make changes to the layout. Workpieces can be changed from raw to finished or the amount can be adjusted.

Click next to go to start automation screen.

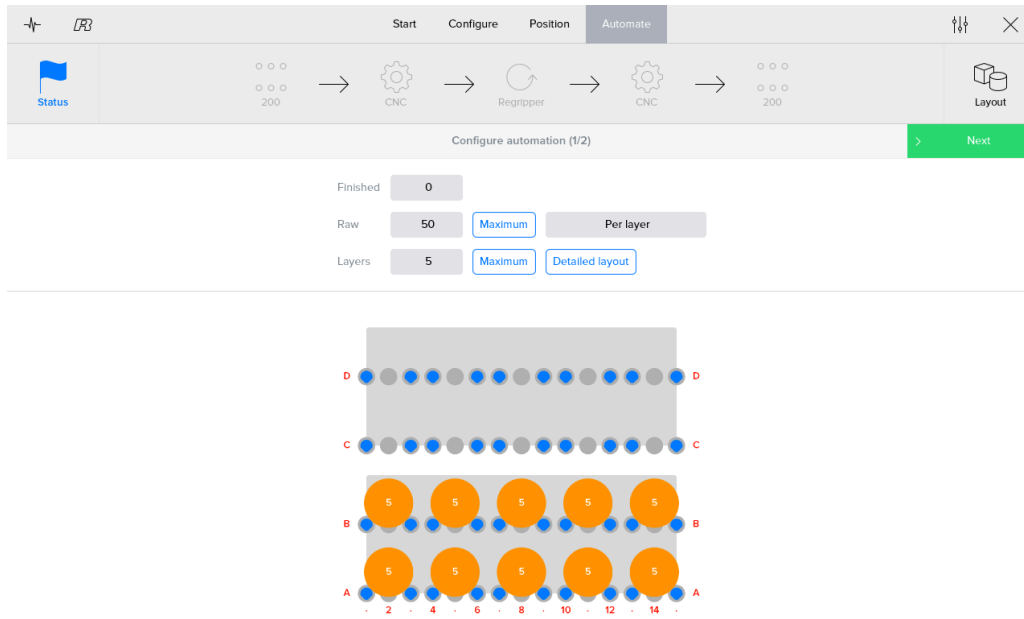

Figure 3.57. Configure automation for circular workpieces

Start automation (2/2)

In this section, an overview of the automation process is given. Before the process is started, an overview of the used grippers is shown. It is important for the user to check these values. Once the grippers are setup correctly and all alarms are cleared, the automation process can be started.

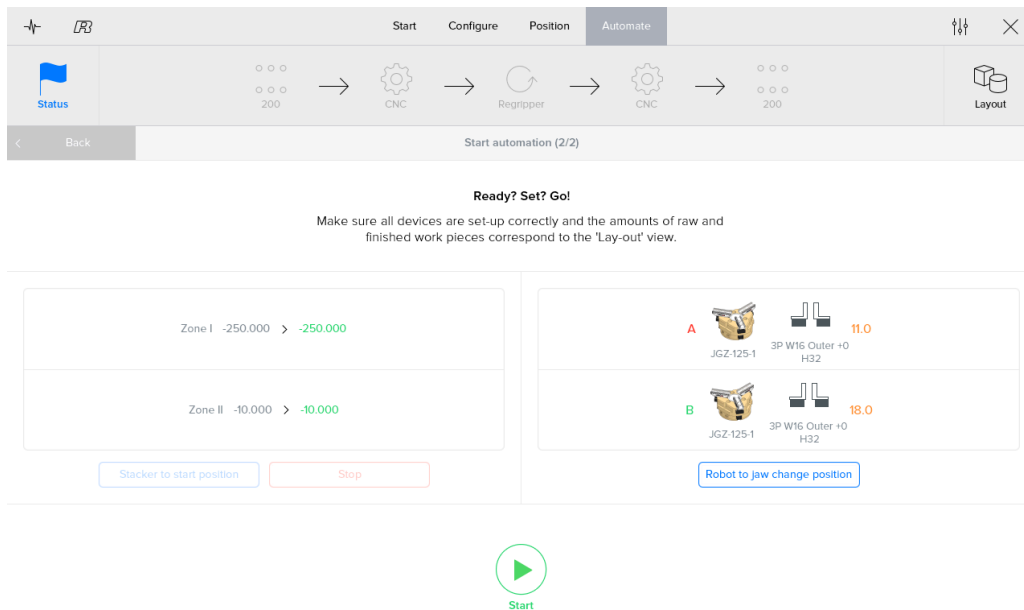

Figure 3.58. Start automation (3 point grippers)

Execution

While the execution is active, the live status screen is shown. This screen contains six parts:

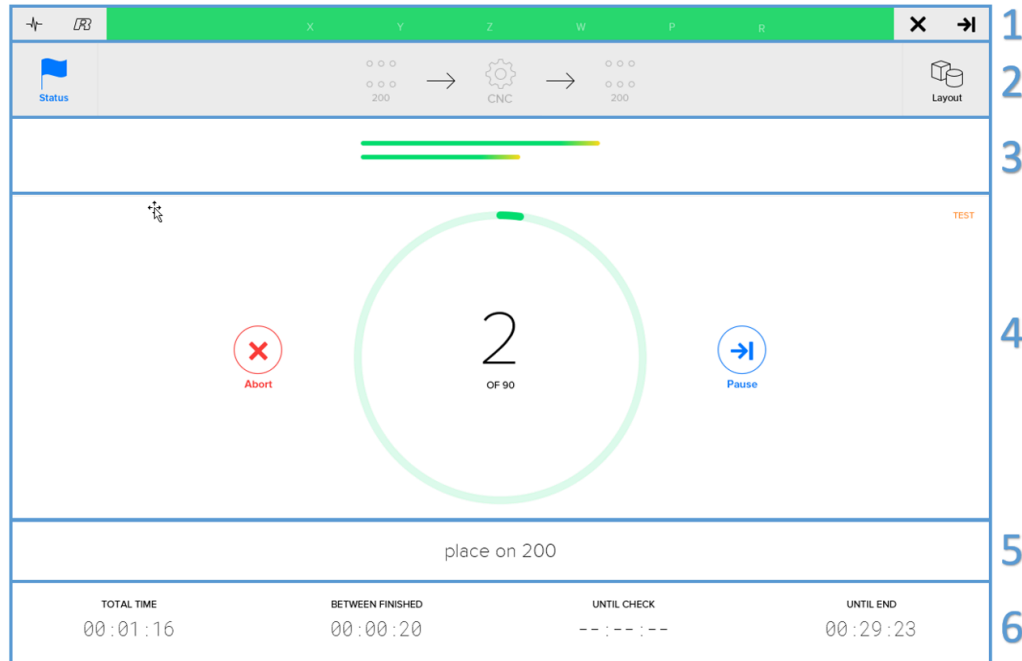

Figure 3.59. Automate status view

1. **Remaining movement:** When performing certain movements, the status bar will display the distance to be covered to the next point in every direction individually. This can be useful to check all settings of a new workpiece.
The different states of the process are indicated with three different colors:
 - Red: Error occurs in the system.
 - Blue: Paused process, in this state workpieces can be changed.
 - Green: Running
2. **Layout:** In this section, the layout of the system is shown. This layout updates on-the-fly. It shows an overview of each stacking device and the amounts of workpieces located on these devices.
3. **Progress overview:** The progress overview shows the progress for each workpiece that is currently being handled. The green part shows the steps that have been taken. The yellow part shows the action that is currently being executed.
4. **Status overview:** The status overview shows the ratio of the number of workpieces that are finished with respect to the total number of workpieces. Next to the counter, two buttons are present. These buttons are used to control the process execution:
 - Abort: This button will abort the process execution, making the robot stop at its current position.
 - Pause or Start: When the Pause button is pressed, the robot will finish its current action. Afterwards, the automation process will be paused. The execution will stay paused until the user presses the Start button. During the paused state, the amount of workpieces can be altered in the layout section.
5. **Current action view:** A description of the action currently being executed is shown.
6. **Timers:** The timer section shows four different timers:
 - Total time: the total time the execution is already running.
 - Between finished: the time it takes to place a new finished workpiece on the final stacking device after the previous finished workpiece was put. In this way it is easy to calculate how many workpieces will be finished after a certain period of time.
 - Until check/Check at: the time until the next scheduled intervention. It is possible to switch between timers 'Until check' and 'Check at' by clicking on the timer.
 - Until end/Finished at: the time is still takes until the end of the process. It is possible to switch between timers 'Until end' and 'Finished at' by clicking on the timer.

Please note that the actual time of the timers is calculated using the active speed and time used for each action. It is therefore possible these values differ slightly from the actual situation.

TOTAL TIME	BETWEEN FINISHED	UNTIL CHECK	UNTIL END
00:03:18	00:01:09	00:08:29	02:44:17
TOTAL TIME	BETWEEN FINISHED	CHECK AT	FINISHED AT
00:03:33	00:01:09	10:24:07	12:59:54

Figure 3.60. Overview of the timers

3.5.2. Layout

In this section, the layout of the system is shown. This layout updates on-the-fly. It shows an overview of each stacking device and the amounts of workpieces located on these devices.

The layout screen allows the user to modify the amount of raw or finished workpieces. This is, however, only possible if the system is in a paused state.

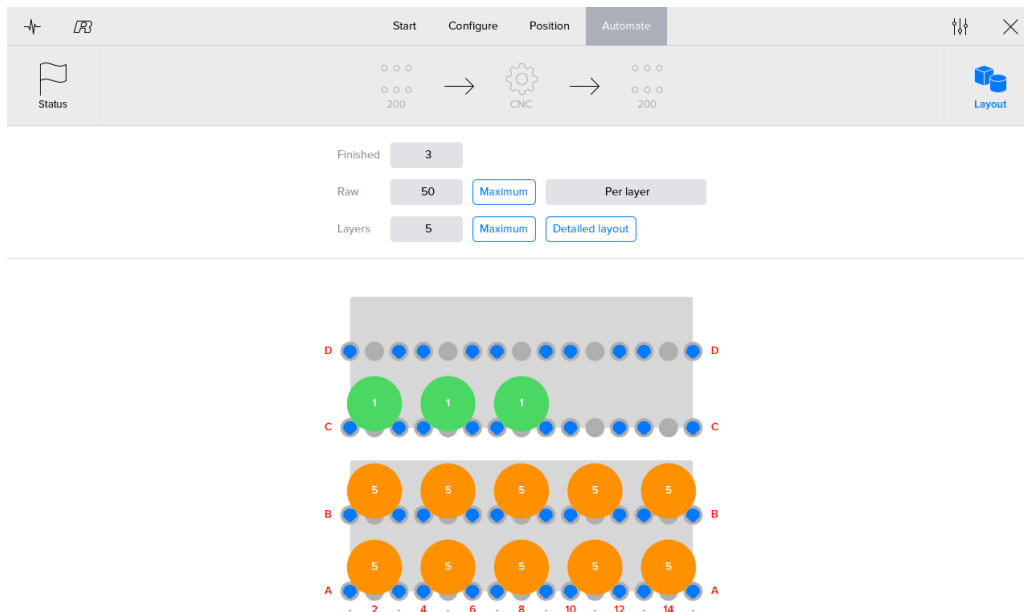

Figure 3.61. Automate layout screen for circular workpieces

3.5.3. Interventions

Interventions are a manner of interrupting the process at specific moments. Each transport action button can be selected to configure an intervention at a desired moment. These interventions will interrupt the process and result in a paused state. The user can choose to add an intervention before the robot picks up a piece or after the robot puts a piece somewhere. The interval controls the desired timing, i.e. if the user wants to check if a piece is still placed correctly in the machine after 10 pieces, an interval of 10 should be entered.

It is possible to check the remaining number of pieces at all time by clicking on the intervention. The counter of how many workpieces it takes to reach the next intervention can be reset using the 'Reset' button.

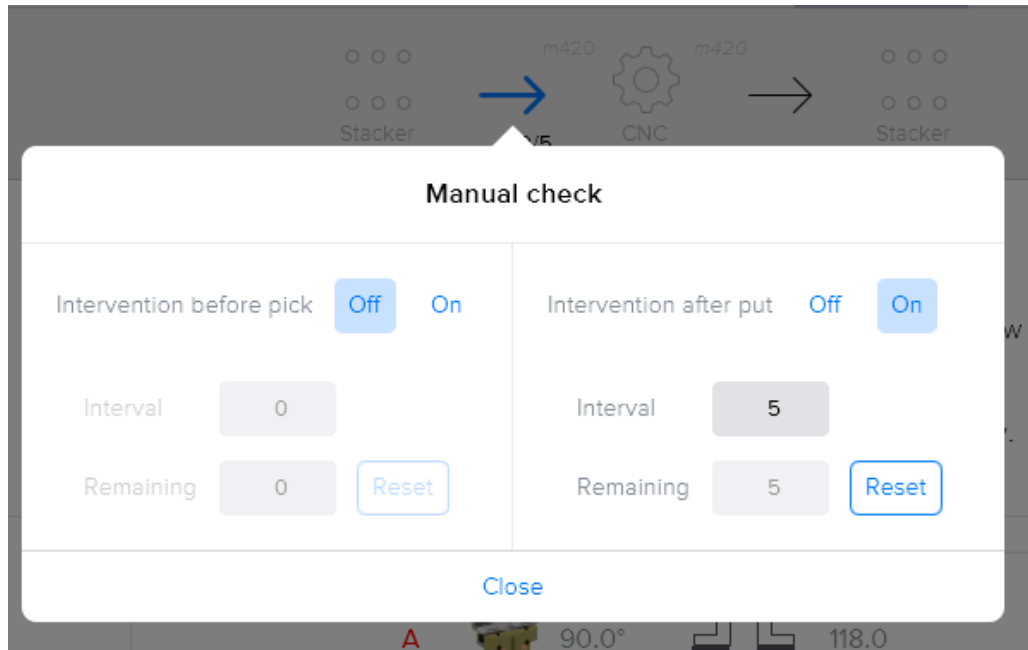

Figure 3.62. Intervention screen

3.6. Admin

In this part of the software, users can change system preferences in the 'Tools' menu, e.g. language and keyboard type. Additionally, customer-specific appliances, e.g. grid plates and fixtures, can be configured in the 'Config' menu.

Note that not all settings are available for all users. Depending on the software, configuration settings might be hidden or disabled and only become visible after logging in as a specific user. Some preferences are used during installation and service should only be altered by certified RoboJob Service partner. These settings can only be accessed after authentication.

3.6.1. Preferences

At the top the software language can be selected as well as a fall back language in case a translation is not available. Underneath, the keyboard layout can be changed. The last option can be used to save additional log files. Please note the software has to be restarted for these changes to be applied.

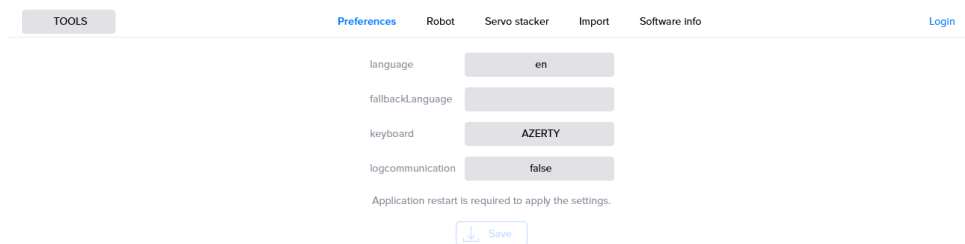

Figure 3.63. Preferences

3.6.2. Robot

The robot tab can be used to move the robot.

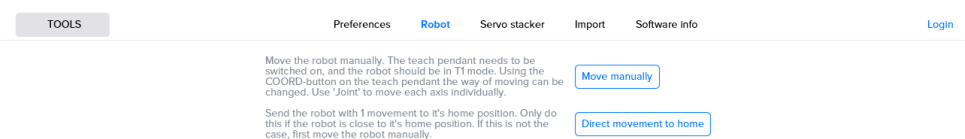

Figure 3.64. Robot

- **Move manually** allows the user to move the robot using the Teach Pendant.
- **Direct movement to home** will cause that the robot will go directly to its home position.

When performing a direct movement to home, the robot will use the shortest route and will not take into account the devices in the area. Only perform this movement when the robot is close to the home position or when no collision can occur.

On the other hand, when using the 'Home' button in the robot menu, the robot will take the route he used to reach the current position and will so take into account devices in the area. This movement is safer to perform when far from the home position.

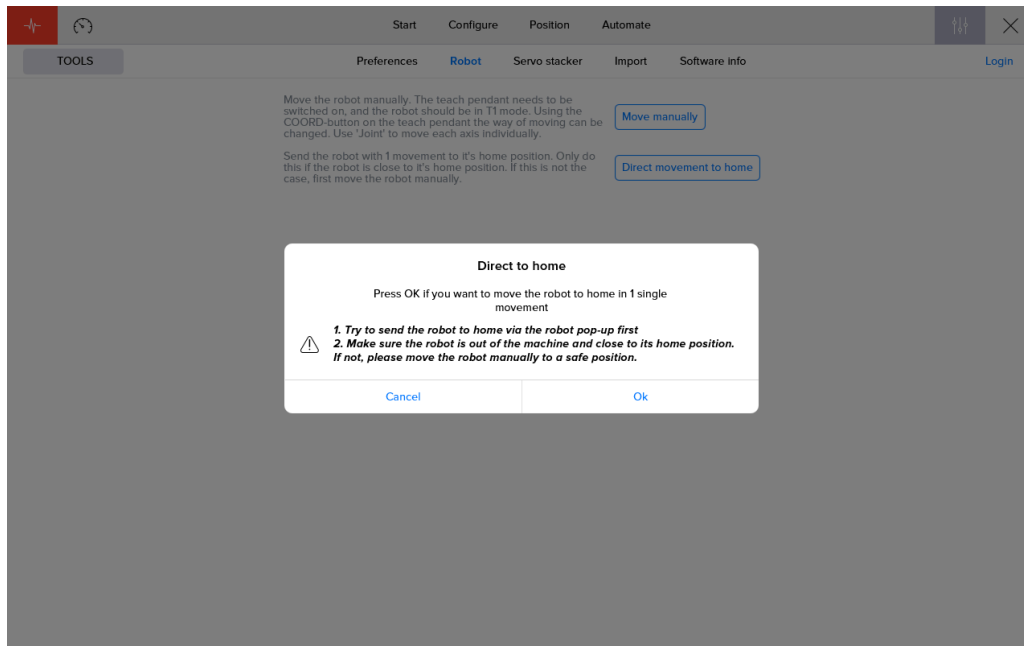

Figure 3.65. Direct movement to home

When using the pop-up screen during direct movement to home, the speed of the robot can be adjusted by using +/- 5%. The movement can be stopped or reset.

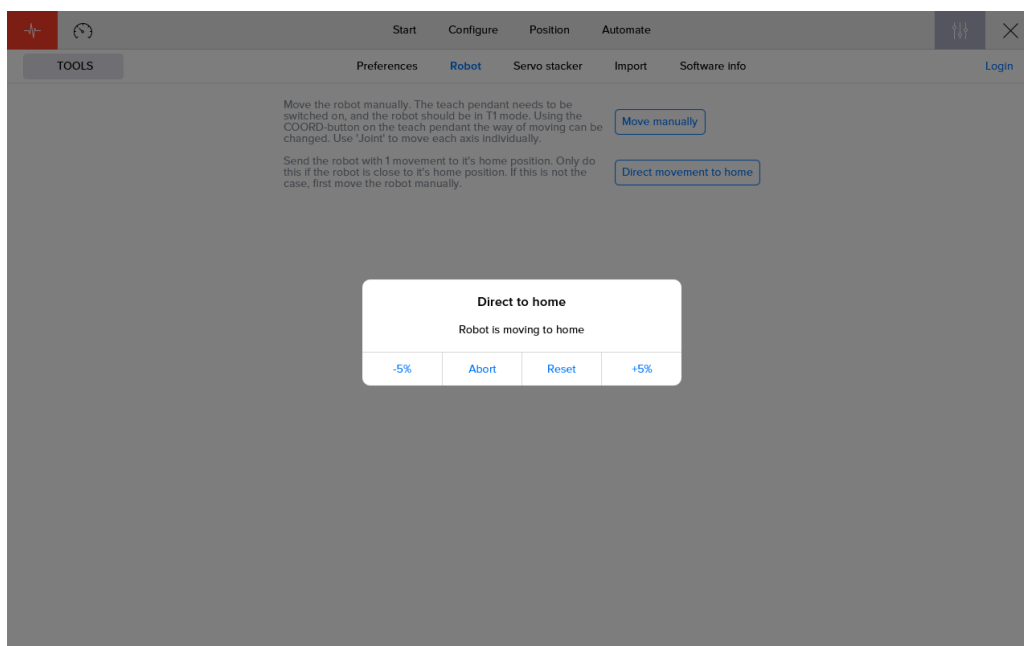

Figure 3.66. Direct movement to home: pop-up screen

3.6.3. Servo stacker

When using a stacker the height of the stacker can be manually adjusted using the 'Servo stacker' menu. For each zone of the stacker the menu indicates at which height the stacker is currently positioned. By filling in the 'Go to' field the height of each zone can be separately changed.

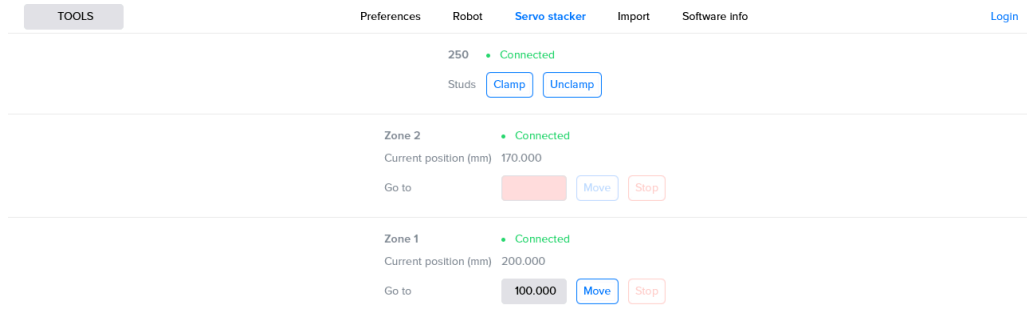



Figure 3.67. Servo stacker

3.6.4. Import

A configuration can be loaded in the software using the 'Import' button in the 'Tools' menu. The import icon represents reading from a file. When clicking the import icon, the user will be prompted to select one or multiple files. The information contained in the files are validated and the results are shown on the screen. If no errors are present the files can be saved in the software. The save button will become available. After saving, the imported configurations will be available in the software. When there are validation errors or other files need to be imported, use the revert icon  to revert the import screen to its initial state.

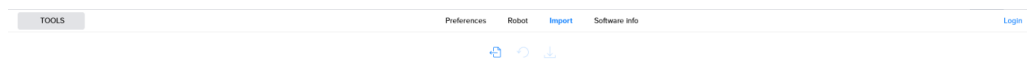

Figure 3.68. Import yaml file

3.6.5. Software info

The last submenu of the 'Tools' menu gives more information about the used software. The current version of robot and device interface software can be find in this subsection.

TOOLS		Preferences	Robot	Import	Software info	Login
Git tag			v3.0.7			
Build time			26-09-2018 17:56			
Git branch			release/v3.0.1			
Build host			ALU-PC-114			
Git commit id			ea8b62c			
Git commit time			26-09-2018 17:53			
Git tag extra commits			0			
Git tags			v3.0.7			
Database last migrated			22-10-2018 10:58			
Database migration version			18.06			
Robot software version						
Minimum robot software version			V2.0.0			
Device Interface software version						
Minimum Device Interface software version			1.5.0		Ignore version problem	

Figure 3.69. Software info

3.6.6. Grids

On some stacking devices, it is possible to apply a grid layout, as a means of determining the stacking locations. When changing to the 'Config' menu, these grid layouts can be configured. An unlimited number of grids can be added to the system.

Three main part in the grids section can be adjusted:

1. In the selection field an existing grid plate can be selected or deleted or a new grid plate can be added.
2. The layout of this grid is visualized.
3. The configuration of the grid can be edited.

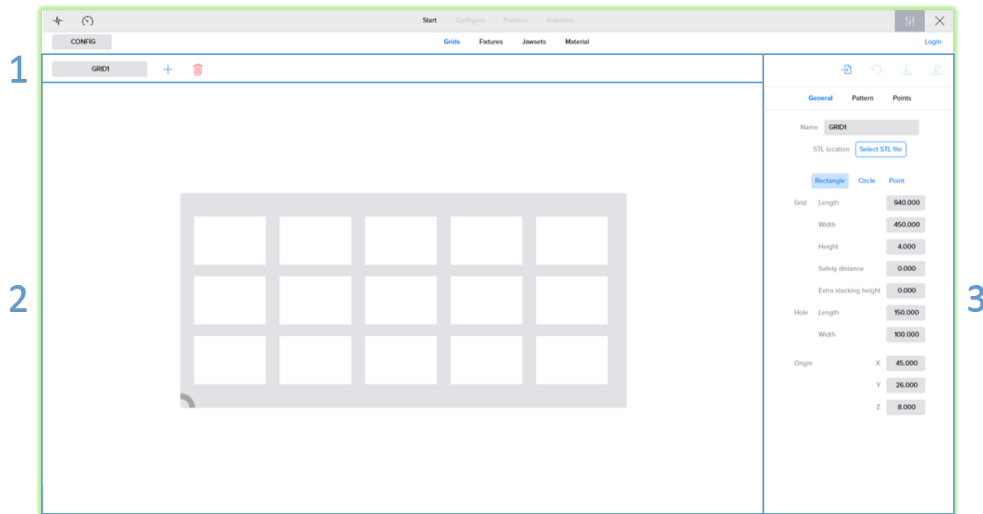

Figure 3.70. Grids admin

The grid configuration is divided in three sections:

General

General settings with respect to the grid and the holes of the grid can be entered. If you have an STL file containing the data of the grid you want to use you can skip the following steps. Use the 'Select STL file' button to import the specifications of the grid.

As noted earlier, the name must always be unique. Beneath the field to enter the name, one can find the types of holes that can be created:

- **Rectangle:** a grid with rectangular holes
- **V-profile:** a grid with V-shaped profiles as holes
- **Circle:** a grid with circular holes
- **Points:** a grid where the workpieces are stacked on the given points. This can be useful when the workpieces slide over a pin for example.

After choosing the type of grid, the parameters of the grid itself can be entered: length, width, height. Other parameters can be entered as well:

- **Safe distance:** This value is taken by the robot as an additional safe distance. The robot will take this value into respect and will not move down towards the grid before reaching the position exactly above the workpiece.
- **Extra stacking height:** This is the height that can be used to stack workpieces. If this value is 0, only the base of the grid can be used as this is the only support for the workpieces. Only one layer can be stacked on the grid. In the case where the grid holds an extra support at a certain height, it will be possible to use multiple layers of workpieces on a grid.

After filling in the general parameters of the grid, the parameters of the hole should be entered. Note that these parameters can differ for the type of hole that was chosen earlier. In case of rectangular holes, the length and the width of the hole must be entered. For V-shaped profiles, the length, width and angle of the V-profile are needed. For circular holes, the diameter is sufficient. For point grids, no dimensions need to be entered in this section.

As a last subsection in the 'General' section, the default origin of the grid must be filled in. The origin is the bottom left corner of the plate relative to the bottom left corner of the device where the grid is applied upon.

The z coordinate of the origin is the height where the bottom of the workpieces must be situated relative to the stacking device.

Note that the origin can be configured and saved per process. The value given in the admin menu is used as the default value.

Pattern

To specify a pattern for the holes, the origin of the first hole, the orientation of the holes and the distance between the origins of the holes should be entered. Note that the origin of the holes is different for each hole type:

- Rectangle: The origin is the bottom-left corner of the rectangle.
- V-profile: The origin is the bottom-left corner of the profile.
- Circle: The origin is the center of the circle.
- Point: The origin is the center of the point.

The spacing to be entered is the value from the origin of the first hole up to the origin of the next hole in the X-direction and in the Y-direction. Make sure this distance is large enough to avoid overlapping of the holes.

To apply a certain pattern, the 'Calculate' button must be clicked. The 'Clear' button will clear all the holes in the layout when pushed. When changing the pattern settings, the layout should be cleared first before recalculating the pattern of the grid.

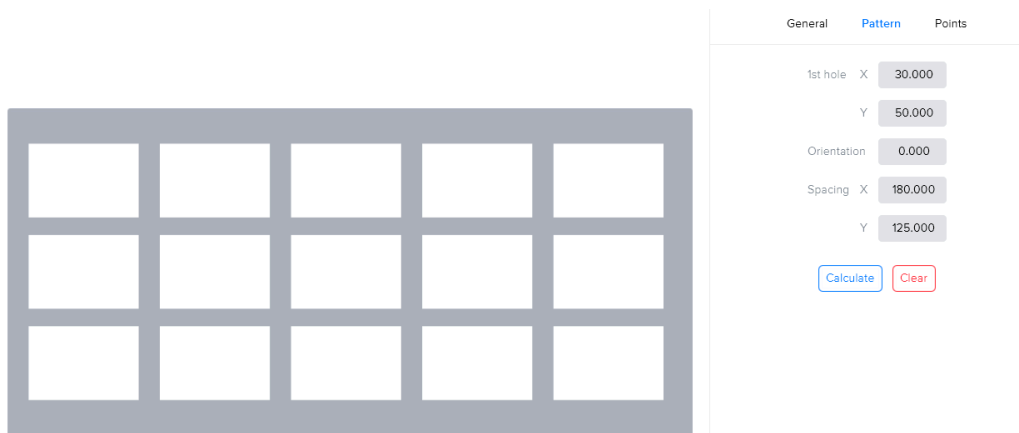

Figure 3.71. Pattern of grid holes for rectangular holes

Points

In this section, a list containing all hole positions is shown. Each line gives the X and Y coordinate of a holes origin, relative to the bottom-left of the grid plate. Each individual position can be changed and positions can be added or removed. The order in this list also determines the order in which workpieces will be handled. It is possible to change the ordering of a position by dragging its index number and moving it to another position.

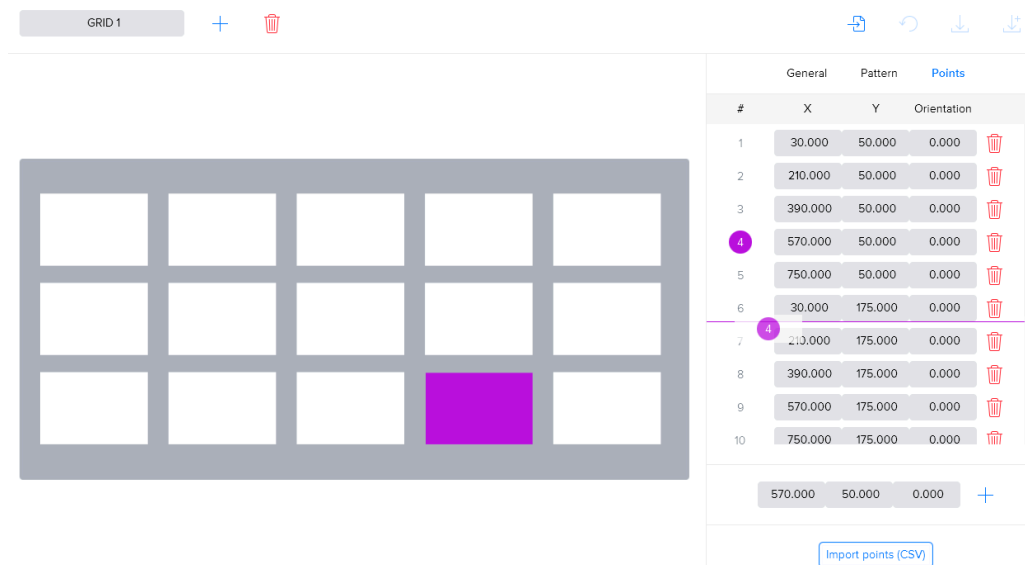

Figure 3.72. Change grid hole ordering

In these subsection, it is also possible to import a list of points from a CSV file. A CSV file is a file that contains certain values separated by a semicolon ‘;’. The files should be structured as follows:

- The first row is the header row and should be: X; Y; Orientation
- The following rows contain the values: X coordinate, Y coordinate and the orientation of the hole in degrees. The values must be separated by a ‘;’ and the decimal separator should be a ‘.’.

Note that the CSV file must have the correct structure to be able to import the file.

3.6.7. Fixtures

In this admin sections clamping systems in the machine can be edited, added or removed.

Fixtures are defined by a unique name. Additionally, an image can be attached to more easily identify it. To change the image, just click on the image and select an image on the hard disk of the IPC. For the best result use a square-sized image, i.e. 501 x 501 pixels, with a transparent background.

Other parameters need to be entered to create a realistic visualization of the fixture:

- **Type:** The type depends on the amount of gripping points, i.e. three point gripping, two point gripping or two types of clamping the workpiece against a fixed plate with one gripper.
- **Orientation:** Entered in degrees.
- **Depth:** The clamp depth will be used by the system when suggesting how deep workpieces are placed in the fixture.
- **Base layer**
- **Jaws:** Dimensions of the jaws.
- **Pink target:** The pink target position defines the location of the fixture, relative to the origin of the CNC machine.
- **Amount of fixtures**

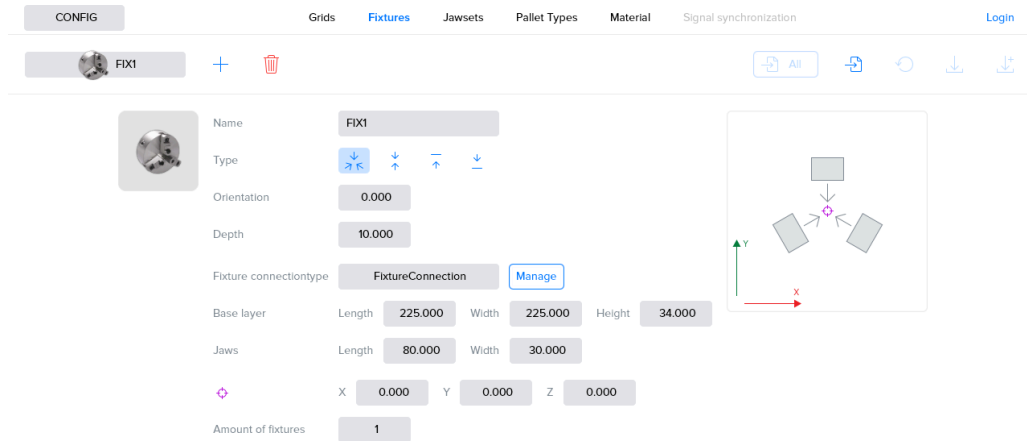

Figure 3.73. Fixtures admin for a turning machine

3.6.8. Jawsets

It is possible for a user to manually insert its own jaws by the use of the 'Jawset' admin menu. The screen is built into two parts: a visualization part and a settings part. The settings are divided into three subparts: general, shape and visualizations.

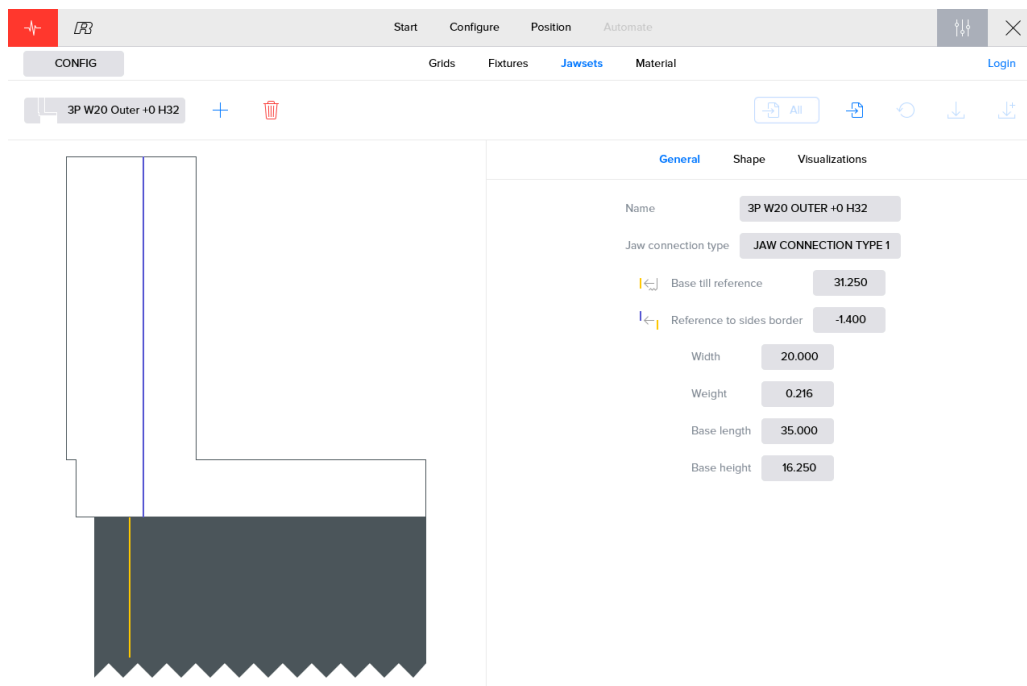

Figure 3.74. Jawset admin

A jaw is defined with two sides. A left and a right side divided by a blue marker. Both sides of the jaw can be used depending on the direction the jaw is mounted on the jaw base. The concept of the two sides, side 1 and 2, is important to be able to correctly define new jaws.

General

The general screen contains settings with respect to the base and the jaws, which are:

- **Name:** The name of the jaw set.
- **Jaw connection type:** This type is the link between the jaw and the gripper on which the jaw can be placed. The default connection type is "Default RBJ jaw". This is the correct connection type for most installations.
- **Base till reference:** The distance from the base of the jaw until the reference that is given on the jaw in yellow. For the RoboJob standard jaws, the reference is the small arrow pointing down.

- **Reference to sides border:** The distance from the reference to the border of the sides, marked in blue. Note that if the blue marker is positioned right of the yellow reference, the entered value is negative. The blue marker is just a virtual division between the two sides of a jaw and can thus be chosen arbitrarily.
- **Width:** The width of the jaw.
- **Weight:** Weight of the complete jaw set.
- **Base length:** Length of the jaw base of the jaw, i.e. the dark part.
- **Base height:** Height of the jaw base of the jaw, i.e. the dark part.

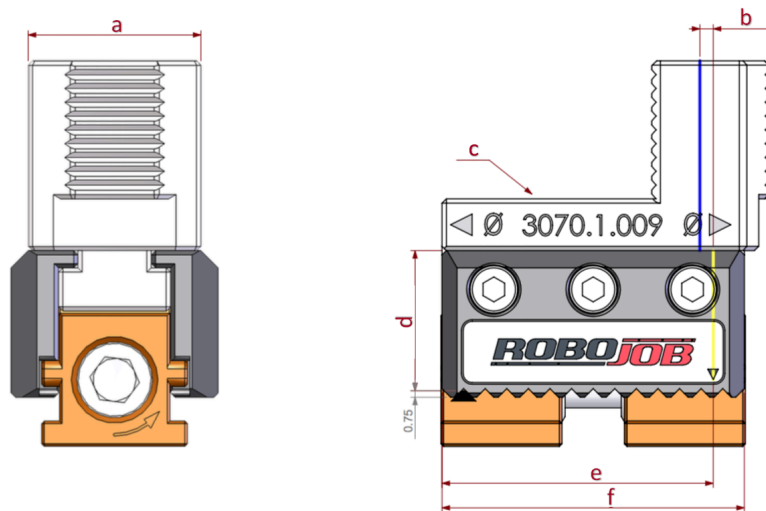

Figure 3.75. Visualization of the jaw inputs

Shape

The 'Shape' submenu is used to define the two sides of the jaw. The submenu is split into two parts separated by a blue line. This blue line represents the blue line that is also visible on the visualization of the jaw and is thus the border of the two sides, like mentioned earlier.

The bottom part of the screen contains the measurements of the jaw sides. Each side of the jaw contains two steps. By clicking on the index of the step, the step is made purple. This makes it easy to see which measurements are applied on which step. Note that the steps are ordered from top to bottom.

For each step the length and height must be entered. This can be done by using the red text fields above the header containing "# Length Height I O". Clicking on the '+' button will add a new step on top of the existing steps. After adding the step, one must choose whether this step of the jaw is to be used for inner ('I' button) or outer ('O' button) gripping. If this part of the jaw should not be used for gripping at all, none of the two toggle buttons must be clicked.

Note that there must always be at least one toggle button selected, inner or outer, for the entire jaw.

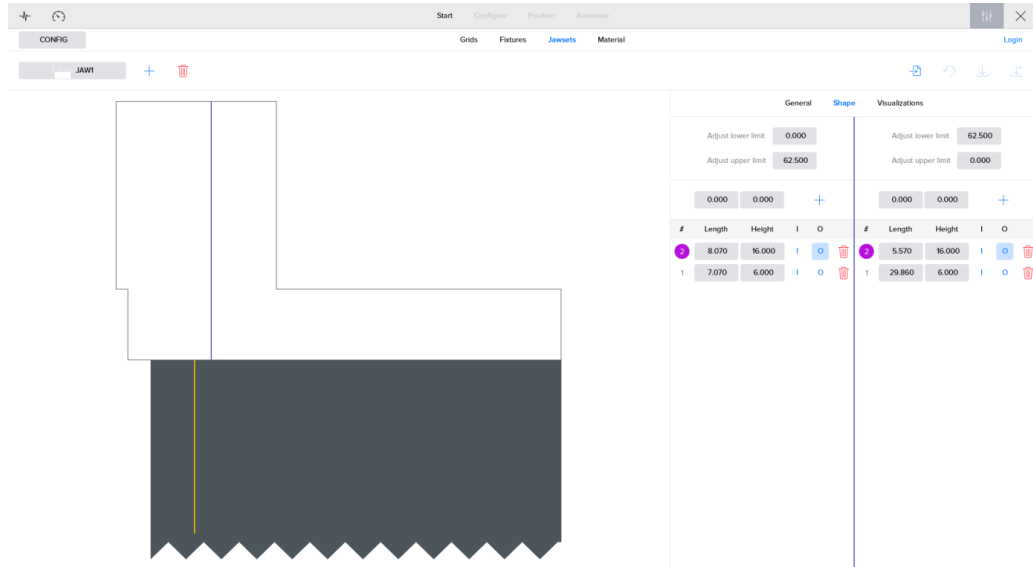

Figure 3.76. Shape submenu for defining new jaw sets

After giving in the necessary steps, the values for the adjust upper and lower limit of the jaw locations has to be entered. The adjustment for the upper and lower limit can be seen as a reduction or increase in the possible jaw locations on the jaw base of the gripper. Every side or direction in which the jaw is mounted, has its own limits for positioning the jaws on the jaw base of the gripper.

The software calculates the location where the jaw should be placed during the positioning step when configuring a process. The reference indicated by the yellow marker in the software and the arrow on the actual jaw, points to a value on the scale on the jaw base of the gripper. In theory the reference can be set on all positions of the scale, but in practice it is not always possible because of mechanical limitations. The slider of the jaw may not stick out to the side of the jaw base. Therefore the possible gripper locations should be limited in the software.

The scale indicated on the gripper jaw base is configured during installation. The first and last value indicated on the scale are used as the limits by default. The input fields adjust upper and lower limit can be used to adjust these limits. The values are expressed in the same units as the scale on the jaw base of the gripper.

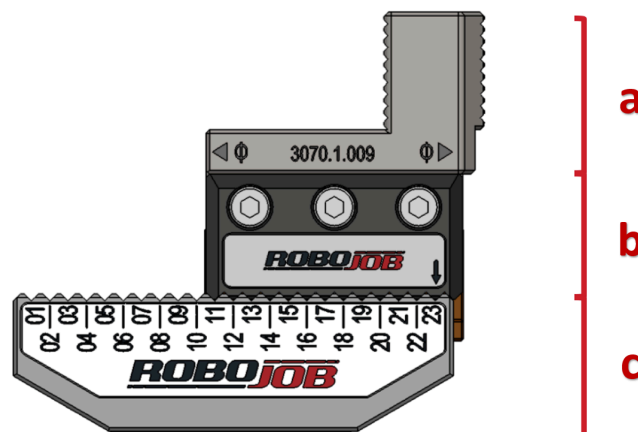



Figure 3.77. Parts of the jaw

Visualizations

The visualizations screen is used to create jaws by importing the STL file. To import a new file you need to execute following steps:

1. Typing a name in the text field.
2. Importing an STL file by clicking on 'Select STL file' and selecting the correct file.

3. Clicking '+' to add the jaw to the library.

You can delete an existing jaw by clicking the red button .

Do not forget to push the save button. If you leave the page without saving the selected jaws will not appear in the library.

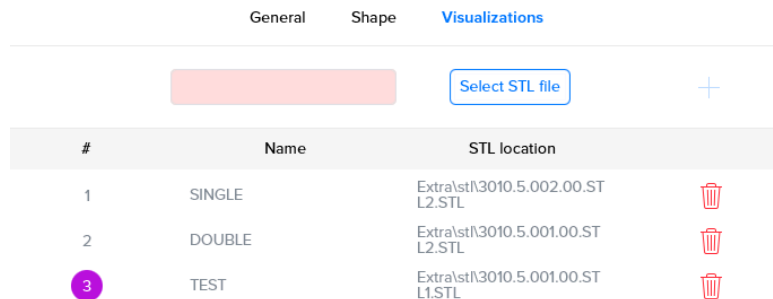



#	Name	STL location	
1	SINGLE	Extra\stl\3010.5.002.00.ST L2.STL	
2	DOUBLE	Extra\stl\3010.5.001.00.ST L2.STL	
3	TEST	Extra\stl\3010.5.001.00.ST L1.STL	





Figure 3.78. Visualizations

3.6.9. Material

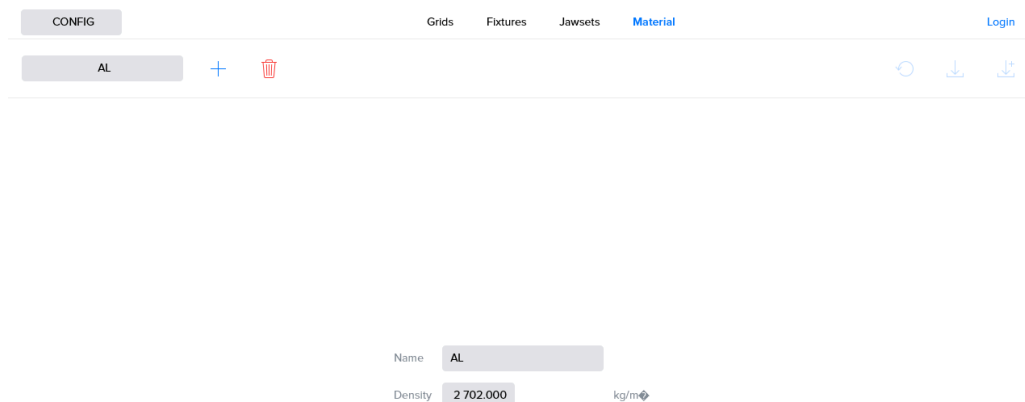
The material section gives the opportunity to change material properties or to add a new material. These materials are used to indicated the material, and so the weight, of the workpieces.



CONFIG Grids Fixtures Jawsets **Material** Login

AL +    

Name AL

Density 2 702.000 kg/m³

Figure 3.79. Material

3.6.10. Shaft caliber

The shaft caliber can be used to position shafts on the shaft racks. Multiple parameters need to be entered to configure the shaft caliber:

- **Type:** Two types are available for the shaft caliber.
 - Front types are used for shaft racks put under an angle on the stacker. The shaft will lean against the support due to gravity.
 - Mid types are used when the shaft rack is placed horizontally on the stacker. The shafts are placed in V-shaped supports.

- **Name:** Name of the shaft caliber.
- **Shaftcaliber connection:** Connection with the shaft rack.
- **Number of support (#):** This determines the number of shafts that can be hold by two calibers.
- **Support width (A):** The width of one support.
- **Support height (B):** The height of one support.
- **Range of supports (C):** The distance between two succeeding supports.
- **Y step support (D):** The distance between two left sides of two succeeding supports. This distance is equal to the length of one support plus the range of supports.
- **Offset to first support (E):** The distance to the first shaft on the caliber.
- **Total height of caliber (F):** Total height of the shaft caliber.
- **Angle (Only used with type Mid):** When using V-shaped supports the angle of the V-profile should be entered as an extra parameter.

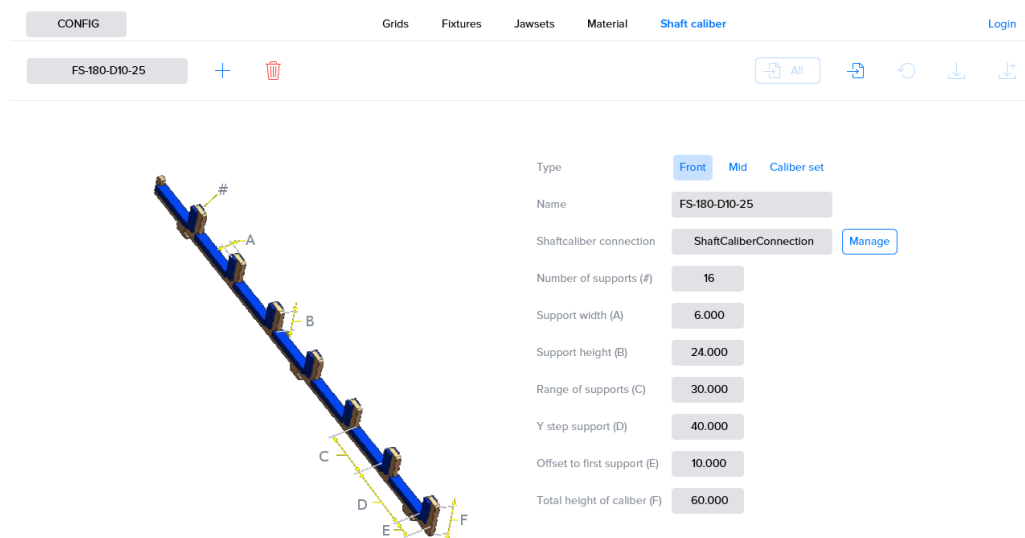

Figure 3.80. Shaft caliber

3.6.11. Export

Certain software entities (jaws, gripper, grids, ...) can be exported and imported in the software. This makes it possible to interchange configurations between various RoboJob installations. It is for example possible to export a grid that is configured on installation A and import it on installation B.

Items that can be exported will have an export button available in their section. This symbol represents writing to a file. When exporting configurations, the user will be prompted where to save the file. This file can be taken to a different installation.



Figure 3.81. Export to yaml file



Appendix A. List of alarms

Please contact the RoboJob Helpdesk on +32 15 70 89 70 or service@robojob.eu in case no remedy is given.

A.1. Robot alarms

ROB.1: Robot alarm.

This is a general robot alarm. The actual error is coming from the FANUC robot and can be consulted on the Teach Pendant.

ROB.2: Battery low, do not power off the robot.

The batteries of the robot need to be replaced: 4 Alkaline batteries type C. It is important that you do not switch off the robot.

Remedy: Contact RoboJob for the correct procedure.

ROB.3: Watch out! The robot is in step mode.

Remedy: Turn off step mode by pressing the STEP button on the FANUC Teach Pendant.

ROB.4: Teach Pendant should be turned on (T mode).

Remedy: Turn on the FANUC Teach Pendant by switching the left upper button to ON.

ROB.5: Deadman switch must be pressed (T mode).

Remedy: Press one of the yellow buttons on the rear side of the FANUC Teach Pendant. Note that you slightly have to press it until you feel a click. Do not press it with full power, since this will be the same as releasing the deadman switch for safety reasons.

ROB.6: Teach pendant should be off (Auto mode).

Remedy: Turn off the FANUC Teach Pendant by switching the left upper button to OFF.

ROB.7: Motion is held.

Remedy: Reset all errors on the IPC using the Alarms menu. After resetting all errors, push the green RUN button next to the IPC screen.

ROB.8: Door was not open; motion disabled.

Cause: The robot needs to move inside the machine, but the doors of the machine signal that they are closed/not open.

Remedy: Check that the doors of the machine are open/closed.

ROB.100: Not in IP.

Remedy: Reset the robot on the IPC using the Alarms menu and send the robot to Home using the Robot menu.

ROB.101: IO has unexpected value.

When the gripper is expected to hold a workpiece, but no input is measured, the IO will have an unexpected value. This can also be the case when the gripper is expected to not hold a workpiece.

Remedy: Check the environment of the gripper and make sure nothing unexpected is influencing the gripper.

ROB.102: No shaft detected.

Remedy: Check the gripper and the placement of the shafts.

ROB.103: Signal was already high before measurement.

When the laser beam is interrupted before measurement, an obstacle can be between the measurement system and the shaft or the shaft is longer than expected.

Remedy: Check the environment of the measurement system and the shaft.

A.2. CNC alarms

A.2.1. Doors

DR.0: Safety not ok.

One of the safety inputs of the door is not right.

Remedy: Check all safety measures of the door.

A.2.2. Machine

MG.0: Machine alarm input is active.

Remedy: Check the error given by the machine. If necessary, contact the producer of the machine.

MG.1: In cycle/cycle finished config error.

Remedy: At least one of the settings 'Use in cycle' or 'Use cycle finished' should be set to true.

MG.2: Not in auto mode.

Remedy: Switch the machine to AUTO mode.

A.2.3. Action

Multiple action errors can occur for different devices. The name of the error is built up with three parts: AC (action), the abbreviation of the device and the number of the error. The number of the error itself contains two digits: the first digit indicates the part of the action and the second digit indicates the possible status of the device. For each device all parts of the action are explained in their section. When a certain alarm can occur in different stages of an action, the first digit of the number is replaced by 'x'.

Machine (M)

The actions of the machine are divided into five parts. The first digit of the number resembles this stage of the action:

1. Start cycle
2. Reset NC
3. Finish m-code
4. Power off
5. Select program

In each stage several execution statuses and errors can occur:

AC-M-1.1: Client disconnected.

Remedy: Check the connection.

AC-M-1.2: Machine alarm.

Remedy: Check the error given by the machine. If necessary, contact the producer of the machine.

AC-M-1.3: Start timeout.

The machine could not be started within the requested time.

Remedy: Check the environment of the machine and try to start the machine again.

AC-M-2.1: Client disconnected.

Remedy: Check the connection.

AC-M-2.2: Machine alarm.

Remedy: Check the error given by the machine. If necessary, contact the producer of the machine.

AC-M-2.3: Reset NC timeout.

NC could not be resetted.

Remedy: Try to reset again.

AC-M-3.1: Client disconnected.

Remedy: Check the connection.

AC-M-3.2: Machine alarm.

Remedy: Check the error given by the machine. If necessary, contact the producer of the machine.

AC-M-3.3: Finish m-code timeout.

The m-code can not be finished within the requested time.

AC-M-3.4: No valid m-code active.

The machine gives a m-code that is not mapped in the software.

Remedy: Check the m-code mapping in the IPC software.

AC-M-4.1: Client disconnected.

Remedy: Check the connection.

AC-M-4.2: Machine alarm.

Remedy: Check the error given by the machine. If necessary, contact the producer of the machine.

AC-M-4.3: Power off timeout.

The machine can not be powered off.

Remedy: Try again to power off the machine.

AC-M-5.1: Client disconnected.

Remedy: Check the connection.

AC-M-5.2: Machine alarm.

Remedy: Check the error given by the machine. If necessary, contact the producer of the machine.

AC-M-5.3: Select program timeout.

The requested program can not be selected within the requested time.

Fixture (Fx)

The 'x' in the name of the device indicates the number of the fixture, e.g. fixture1. The actions of the fixtures can be divided in eight stages:

1. Airblow
2. Orient
3. Select pressure
4. Clamp (inner)
5. Clamp (outer)
6. Unclamp (inner)
7. Unclamp (outer)
8. Spindle jog (on)
9. Spindle jog (off)
- 10.Dock
- 11.Undock
- 12.Clamp steady rest
- 13.Unclamp steady rest
- 14Engage tail
- 15Retract tail

In each stage several execution statuses and errors can occur:

AC-Fx-1.1: Client disconnected.

Remedy: Check the connection.

AC-Fx-1.2: Machine alarm.

Remedy: Check the error given by the machine. If necessary, contact the producer of the machine.

AC-Fx-1.3: Lost selection.

Remedy: Try to select again.

AC-Fx-1.4: Machine is processing.

Machine is processing the current step.

AC-Fx-2.1: Client disconnected.

Remedy: Check the connection.

AC-Fx-2.2: Machine alarm.

Remedy: Check the error given by the machine. If necessary, contact the producer of the machine.

AC-Fx-2.3: Orient timeout.

The spindle could not be oriented before loading/unloading.

Remedy: Check the environment of the spindle and try to orient again.

AC-Fx-2.4: Lost selection.

Remedy: Try to select again.

AC-Fx-2.5: Machine is processing.

Machine is processing the current step.

AC-Fx-3.1: Client disconnected.

Remedy: Check the connection.

AC-Fx-3.2: Machine alarm.

Remedy: Check the error given by the machine. If necessary, contact the producer of the machine.

AC-Fx-3.3: Select pressure timeout.

The requested pressure could not be selected within the set time.

AC-Fx-3.4: Lost selection.

Remedy: Try to select again.

AC-Fx-3.5: Machine is processing.

Machine is processing the current step.

AC-Fx-4.1: Client disconnected.

Remedy: Check the connection.

AC-Fx-4.2: Clamp timeout.

The clamping could not be executed within the requested time.

Remedy: Check the environment of the clamp and try to clamp again.

AC-Fx-4.3: Unclamp timeout.

The unclamping could not be executed within the requested time.

Remedy: Check the environment of the clamp and try to unclamp again.

AC-Fx-4.4: Clamp overridden by unclamp switch.

While the clamp is closing, the switch to open the clamp is turned on.

Remedy: Turn the switch back to clamping.

AC-Fx-4.5: Unclamp overridden by clamp switch.

While the clamp is opening, the switch to close the clamp is turned on.

Remedy: Turn the switch back to unclamping.

AC-Fx-4.6: Machine is processing.

Machine is processing the current step.

AC-Fx-4.7: Clamp lost selection.

Remedy: Try to select again.

AC-Fx-4.8: Unclamp lost selection.

Remedy: Try to select again.

AC-Fx-5.1: Client disconnected.

Remedy: Check the connection.

AC-Fx-5.2: Clamp timeout.

The clamping could not be executed within the requested time.

Remedy: Check the environment of the clamp and try to clamp again.

AC-Fx-5.3: Unclamp timeout.

The unclamping could not be executed within the requested time.

Remedy: Check the environment of the clamp and try to unclamp again.

AC-Fx-5.4: Clamp overridden by unclamp switch.

While the clamp is closing, the switch to open the clamp is turned on.

Remedy: Turn the switch back to clamping.

AC-Fx-5.5: Unclamp overridden by clamp switch.

While the clamp is opening, the switch to close the clamp is turned on.

Remedy: Turn the switch back to unclamping.

AC-Fx-5.6: Machine is processing.

Machine is processing the current step.

AC-Fx-5.7: Clamp lost selection.

Remedy: Try to select again.

AC-Fx-5.8: Unclamp lost selection.

Remedy: Try to select again.

AC-Fx-6.1: Client disconnected.

Remedy: Check the connection.

AC-Fx-6.2: Clamp timeout.

The clamping could not be executed within the requested time.

Remedy: Check the environment of the clamp and try to clamp again.

AC-Fx-6.3: Unclamp timeout.

The unclamping could not be executed within the requested time.

Remedy: Check the environment of the clamp and try to unclamp again.

AC-Fx-6.4: Clamp overridden by unclamp switch.

While the clamp is closing, the switch to open the clamp is turned on.

Remedy: Turn the switch back to clamping.

AC-Fx-6.5: Unclamp overridden by clamp switch.

While the clamp is opening, the switch to close the clamp is turned on.

Remedy: Turn the switch back to unclamping.

AC-Fx-6.6: Machine is processing.

Machine is processing the current step.

AC-Fx-6.7: Clamp lost selection.

Remedy: Try to select again.

AC-Fx-6.8: Unclamp lost selection.

Remedy: Try to select again.

AC-Fx-7.1: Client disconnected.

Remedy: Check the connection.

AC-Fx-7.2: Clamp timeout.

The clamping could not be executed within the requested time.

Remedy: Check the environment of the clamp and try to clamp again.

AC-Fx-7.3: Unclamp timeout.

The unclamping could not be executed within the requested time.
Remedy: Check the environment of the clamp and try to unclamp again.

AC-Fx-7.4: Clamp overridden by unclamp switch.

While the clamp is closing, the switch to open the clamp is turned on.
Remedy: Turn the switch back to clamping.

AC-Fx-7.5: Unclamp overridden by clamp switch.

While the clamp is opening, the switch to close the clamp is turned on.
Remedy: Turn the switch back to unclamping.

AC-Fx-7.6: Machine is processing.

Machine is processing the current step.

AC-Fx-7.7: Clamp lost selection.

Remedy: Try to select again.

AC-Fx-7.8: Unclamp lost selection.

Remedy: Try to select again.

AC-Fx-8.1: Client disconnected.

Remedy: Check the connection.

AC-Fx-8.2: Jog timeout.

Remedy: Check the environment and try to jog again.

AC-Fx-8.3: Machine is processing.

Machine is processing the current step.

AC-Fx-8.4: Lost selection.

Remedy: Try to select again.

AC-Fx-9.1: Client disconnected.

Remedy: Check the connection.

AC-Fx-9.2: Jog timeout.

Remedy: Check the environment and try to jog again.

AC-Fx-9.3: Machine is processing.

Machine is processing the current step.

AC-Fx-9.4: Lost selection.

Remedy: Try to select again.

AC-Fx-10.1: Client disconnected.

Remedy: Check the connection.

AC-Fx-10.2: Dock timeout.

The fixture gets a timeout during docking a finished workpiece.
Remedy: Check the docking system and try to dock the workpiece again.

AC-Fx-10.3: Undock timeout.

The fixture gets a timeout during undocking a raw workpiece.
Remedy: Check the docking system and try to undock the workpiece again.

AC-Fx-10.4: Dock overridden by undock switch.

While docking, the switch to undock the fixture is turned on.
Remedy: Turn the switch back to docking.

AC-Fx-10.5: Undock overridden by dock switch.

While undocking, the switch to dock the fixture is turned on.
Remedy: Turn the switch back to undocking.

AC-Fx-10.6: Machine is processing.

Machine is processing the current step.

AC-Fx-10.7: Dock lost selection.

Remedy: Try to select again.

AC-Fx-10.8: Undock lost selection.

Remedy: Try to select again.

AC-Fx-11.1: Client disconnected.

Remedy: Check the connection.

AC-Fx-11.2: Dock timeout.

The fixture gets a timeout during docking a finished workpiece.

Remedy: Check the docking system and try to dock the workpiece again.

AC-Fx-11.3: Undock timeout.

The fixture gets a timeout during undocking a raw workpiece.

Remedy: Check the docking system and try to undock the workpiece again.

AC-Fx-11.4: Dock overridden by undock switch.

While docking, the switch to undock the fixture is turned on.

Remedy: Turn the switch back to docking.

AC-Fx-11.5: Undock overridden by dock switch.

While undocking, the switch to dock the fixture is turned on.

Remedy: Turn the switch back to undocking.

AC-Fx-11.6: Machine is processing.

Machine is processing the current step.

AC-Fx-11.7: Dock lost selection.

Remedy: Try to select again.

AC-Fx-11.8: Undock lost selection.

Remedy: Try to select again.

AC-Fx-12.1: Client disconnected.

Remedy: Check the connection.

AC-Fx-12.2: Clamp timeout.

The clamping could not be executed within the requested time.

Remedy: Check the environment of the clamp and try to clamp again.

AC-Fx-12.3: Unclamp timeout.

The unclamping could not be executed within the requested time.

Remedy: Check the environment of the clamp and try to unclamp again.

AC-Fx-12.4: Machine is processing.

Machine is processing the current step.

AC-Fx-12.5: Clamp lost selection.

Remedy: Try to select again.

AC-Fx-12.6: Unclamp lost selection.

Remedy: Try to select again.

AC-Fx-13.1: Client disconnected.

Remedy: Check the connection.

AC-Fx-13.2: Clamp timeout.

The clamping could not be executed within the requested time.

Remedy: Check the environment of the clamp and try to clamp again.

AC-Fx-13.3: Unclamp timeout.

The unclamping could not be executed within the requested time.

Remedy: Check the environment of the clamp and try to unclamp again.

AC-Fx-13.4: Machine is processing.

Machine is processing the current step.

AC-Fx-13.5: Clamp lost selection.

Remedy: Try to select again.

AC-Fx-13.6: Unclamp lost selection.

Remedy: Try to select again.

AC-Fx-14.1: Client disconnected.

Remedy: Check the connection.

AC-Fx-14.2: Engage timeout.

Remedy: Check the environment and try again.

AC-Fx-14.3: Retract timeout.

Remedy: Check the environment and try to retract again.

AC-Fx-14.4: Machine is processing.

Machine is processing the current step.

AC-Fx-14.5: Engage lost selection.

Remedy: Try to select again.

AC-Fx-14.6: Retract lost selection.

Remedy: Try to select again.

AC-Fx-15.1: Client disconnected.

Remedy: Check the connection.

AC-Fx-15.2: Engage timeout.

Remedy: Check the environment and try again.

AC-Fx-15.3: Retract timeout.

Remedy: Check the environment and try to retract again.

AC-Fx-15.4: Machine is processing.

Machine is processing the current step.

AC-Fx-15.5: Engage lost selection.

Remedy: Try to select again.

AC-Fx-15.6: Retract lost selection.

Remedy: Try to select again.

Door (Dx)

The 'x' in the name of the device indicates the number of the door, e.g. door1. The actions of the door only contain one stage:

1. Open/close

In this stage several execution statuses and errors can occur:

AC-Dx-1.1: Client disconnected.

Remedy: Check the connection.

AC-Dx-1.2: Close doors timeout.

The doors could not be closed.

Remedy: Check the environment of the doors and make sure nothing blocks the door. Try to close the door again.

AC-Dx-1.3: Open doors timeout.

The doors could not be opened.

Remedy: Check the environment of the doors and make sure nothing blocks the door. Try to open the door again.

AC-Dx-1.4: Safety not ok.

One of the safety inputs of the door is not right.

Remedy: Check all safety measures of the door.

AC-Dx-1.5: Close overridden by open switch.

While closing the door, the switch to open the door is turned on.

Remedy: Turn the switch back to closing.

AC-Dx-1.6: Open overridden by close switch.

While opening the door, the switch to close the door is turned on.

Remedy: Turn the switch back to opening.

AC-Dx-1.7: Machine is processing.

Machine is processing the current step.

Work area (Wx)

The actions of the work area only contain one stage:

1. Index

AC-Wx-1.1: Client disconnected.

Remedy: Check the connection.

AC-Wx-1.2: Index timeout.

Remedy: Try again.

AC-Wx-1.3: Not in loading area.

Remedy: Check the work area and loading area and make sure the work area of the fixture is within the specified loading area.

*Other (O)***AC-O-1.0: LED off.**

LED is off.

AC-O-1.1: LED on.

LED is on.

AC-O-1.2: LED blinking slow.

LED is blinking slow.

AC-O-1.3: LED blinking fast.

LED is blinking fast.

A.2.4. Ethernet**ME.1: Internal failure ethernet library.**

Remedy: Check the ethernet library.

ME.2: Tool broken.

Remedy: Check the tool and if necessary, replace the tool.

ME.3: Machine error.

Remedy: Check the error on the machine and if necessary, contact the producer of the machine.

ME.4: No ethernet dongle found.

Remedy: Check that the dongle is plugged in in the IPC. Check that the dongle is showing a blinking red light. If not, update the HASP driver of the dongle.

ME.5: No connection with the ethernet library.

Remedy: Check the connection and make sure the cable is plugged in.

ME.6: Ethernet library not installed.

Remedy: Check if the installation is done and if necessary, reinstall the Ethernet library.

A.2.5. Others

OT.0: Pressure level is not ok.

The detected pressure level is not sufficient.

OT.1: Profibus alarm (no connection).

Error with Profibus communication.

OT.2: Fieldbus network alarm (all inputs 0).

The industrial network protocol communication is working, but it received all 0 input bytes. This might indicate a problem with a gateway device.

OT.3: Ethernet/IP alarm (no connection).

Error with Ethernet or IP communication.

OT.4: Fieldbus configuration error (no exchange).

Industrial network protocol configuration error. No communication is possible.

Remedy: Verify configuration.

A.3. Servo Stacker alarms

A.3.1. General

SG.0: Stacker not connected.

Remedy: Check the connection of the stacker and make sure the stacker is plugged in.

SG.1: Problem with the pressure.

Remedy: Check the pressure level of the servo stacker to see if the pressure is in the specified range.

SG.2: Error during clamping.

Remedy: Check the environment of the clamp and the servo stacker and try to clamp again.

SG.3: Error during unclamping.

Remedy: Check the environment of the clamp and the servo stacker and try to unclamp again.

SG.4: Faulty command.

Remedy: Check the command and enter the command again.

SG.5: Emergency stop.

Remedy: Remove all obstacles and check why the stacker has stopped. Restart the servo stacker when the error is solved and obstacles are removed.

SG.10: Robot alarm.

This is a general robot alarm. The actual error is coming from the FANUC robot and can be consulted on the Teach Pendant.

SG.11: Destination of zone 1 out of range.

Remedy: Adjust the destination so the stacker stays in the specified range.

SG.12: Destination of zone 2 out of range.

Remedy: Adjust the destination so the stacker stays in the specified range.

SG.30: Stacker not in position.

The stacker is not in the desired position.

Remedy: Move the stacker plates to the requested position.

A.3.2. Timeout**ST.1: Timeout while unclamping.**

The unclamping could not be finished within the requested time.

Remedy: Check the environment of the clamp and the servo stacker and try to unclamp again.

ST.2: Timeout while clamping.

The clamping could not be finished within the requested time.

Remedy: Check the environment of the clamp and the servo stacker and try to clamp again.

A.3.3. Motor**SM.0: No connection with motor 1.**

Remedy: Check the connection of the motor and make sure everything is connected in the right way.

SM.1: No connection with motor 2.

Remedy: Check the connection of the motor and make sure everything is connected in the right way.

